



SHOWPIX® Pixelation Luminaire

User Manual

© High End Systems, Inc. 2008, All Rights Reserved

Information and specifications in this document are subject to change without notice. High End Systems, Inc. assumes no responsibility or liability for any errors or inaccuracies that may appear in this manual.

Trademarks used in this text: SHOWPIX, High End Systems, and Wholehog are registered trademarks; and Echo, DMX Scratch, Internal Effect, the High End Systems globe logo and the Hog logo are trademarks of High End Systems, Inc. or High End Systems Europe Ltd. Belden is a registered trademark of Belden, Inc. Microsoft, DirectX, and Windows are either registered trademarks or trademarks of Microsoft Corporation in the United States and/or other countries.

Other trademarks and trade names may be used in this document to refer to either the entities claiming the marks and names or their products. High End Systems disclaims any proprietary interest in trademarks and trade names owned by others.

HIGH END SYSTEMS®



SHOWPIX® User Manual Version 2.1
May, 2009

Contacting High End Systems®

Sales Department

High End Systems, Inc.
2105 Gracy Farms Lane
Austin, TX 78758 USA
voice: 512.836.2242
fax: 512.837.5290
Toll Free: 800.890.8989

Customer Service

High End Systems, Inc.
2105 Gracy Farms Lane
Austin, TX 78758 USA
voice: 800.890.8989
fax: 512.834.9195
toll free: 800.890.8989
email: support@highend.com

World Wide Web:

<http://www.highend.com>

Patents

This High End Systems product is protected by patents and pending patent applications.

Patents owned or licensed by High End Systems include:

US 4,392,187; US 4,602,321; US 4,688,161; US 4,701,833; US 4,709,311; US 4,779,176; US 4,800,474;
US 4,962,687; US 4,972,306; US 4,980,806; US 5,010,459; US 5,031,078; US 5,073,847; US 5,078,039;
US 5,186,536; US 5,209,560; US 5,278,742; US 5,282,121; US 5,307,295; US 5,329,431; US 5,331,822;
US 5,367,444; US 5,402,326; US 5,414,328; US 5,426,576; US 5,430,629; US 5,432,691; US 5,454,477;
US 5,455,748; US 5,502,627; US 5,506,762; US 5,515,254; US 5,537,303; US 5,545,951; US 5,588,021;
US 5,590,954; US 5,590,955; US 5,640,061; US 5,647,662; US 5,691,886; US 5,702,082; US 5,728,994;
US 5,758,955; US 5,758,956; US 5,769,527; US 5,769,531; US 5,774,273; US 5,788,365; US 5,794,881;
US 5,795,058; US 5,798,619; US 5,806,951; US 5,812,596; US 5,823,661; US 5,825,548; US 5,828,485;
US 5,829,868; US 5,857,768; US 5,882,107; US 5,921,659; US 5,934,794; US 5,940,204; US 5,945,786;
US 5,953,151; US 5,953,152; US 5,969,485; US 5,980,066; US 5,983,280; US 5,984,248; US 5,986,201;
US 6,011,662; US 6,029,122; US 6,048,080; US 6,048,081; US 6,054,816; US 6,057,958; US 6,062,706;
US 6,079,853; US 6,126,288; US 6,142,652; US 6,142,653; US 6,172,822; US 6,175,771; US 6,188,933;
US 6,208,087; US 6,219,093; US 6,220,730; US 6,241,366; US 6,249,091; US 6,255,787; US 6,256,136;
US 6,261,636; US 6,278,542; US 6,278,545; US 6,278,563; US 6,288,828; US 6,326,741; US 6,327,103;
US 6,331,756; US 6,346,783; US 6,421,165; US 6,430,934; US 6,459,217; US 6,466,357; US 6,502,961;
US 6,515,435; US 6,523,353; US 6,536,922; US 6,538,797; US 6,545,586; US 6,549,324; US 6,549,326;
US 6,563,520; US 6,565,941; US 6,570,348; US 6,575,577; US 6,578,991; US 6,588,944; US 6,592,480;
US 6,597,132; US 6,600,270; US 6,601,974; US 6,605,907; US 6,617,792; US 6,621,239; US 6,622,053;
US 6,635,999; US 6,648,286; US 6,664,745; US 6,682,031; US 6,693,392; US 6,696,101; US 6,719,433;
US 6,736,528; US 6,771,411; US 6,775,991; US 6,783,251; US 6,801,353; US 6,812,653; US 6,823,119;
US 6,865,008; US 6,866,390; US 6,866,402; US 6,866,451; US 6,869,193; US 6,891,656; US 6,894,443;
US 6,919,916; US 6,930,456; US 6,934,071; US 6,937,338; US 6,955,435; US 6,969,960; US 6,971,764;
US 6,982,529; US 6,988,805; US 6,988,807; US 6,988,817; US 7,000,417; US 7,011,429; US 7,018,047;
US 7,020,370; US 7,033,028; US 7,048,838; US 7,055,963; US 7,055,964; US 7,057,797; US 7,073,910;
US 7,078,869; US 7,092,098; US 7,119,902; US 7,161,562; US 7,175,317; US 7,181,112; US 7,206,023;
US 7,210,798; US 7,253,942; US D347,113; US D350,408; US D359,574; US D360,404; US D365,165;
US D366,712; US D370,080; US D372,550; US D374,439; US D377,338; US D381,740; US D409,771;
AT E169413; CA 2142619; CA 2145508; CA 2245842; DE 22588.4-08; DE 621495; DE 655144;
DE 69320175.4; DE 69322401.0; DE 69331145.2; DE 69525856.7; DE 69734744.3; DE 797503;
DK 0655144; DK 1447702; EP 0475082; EP 0621495; EP 0655144; EP 0662275; EP 0767398; EP 0797503;
EP 0969247; EP 1447702; ES 0621495; FR 0621495; FR 0655144; FR 0662275; FR 1447702; GB 2043769B;
GB 2055842B; GB 2283808B; GB 2290134B; GB 2291814B; GB 2292530B; GB 2292896B; GB 2294909B;
GB 2295058B; GB 2303203B; GB 2306887B; GB 2307036B; GB 2316477B; IE 0621495; IT 034244BE; 2005;
IT 0621495; IT 0655144; JP 3495373; JP 3793577; NL 0621495; NL 0797503; NL 0969247; UK 0621495;
UK 0655144; UK 0662275; UK 0797503; UK 0969247; UK 1447702;

Declaration of Conformity

according to ISO/IEC Guide 22 and EN45104

Manufacturer's name: High End Systems, Inc.

Distributor's name: High End Systems, Inc.
Distributor's address: 2105 Gracy Farms Lane
Austin, Texas 78758 USA

Declares that the product:

Product Name: SHOWPIX
Product Number: All
Product Options: All

conforms to the following EEC directives:

73/23/EEC, as amended by 93/68/EEC
89/336/EEC, as amended by 92/31/EEC and 93/68/EEC

Equipment referred to in this declaration of conformity was first manufactured in compliance with the following standards in 2005:

Safety: EN 60598-1: 1997
EN 60598-2-17; 1990
A1-A3: 1998
A13: 1999

EMC:

EN 55022

Conducted Emissions Class A
Radiated Emissions Class A

ANSI C63.4 Class A
FCC 47 CFR Part 15 Class A
VCCI V-1/2001.04 Class A

EN 55024

EN 61000-4-2 4/8kV
EN 61000-4-3 A1 3V/m
EN 61000-4-4 1kV/0.5kV
EN 61000-4-5 2kV/1kV
EN 61000-4-6 3 Vrms
EN 61000-4-11 >95%-0.5p, 30%-25p, >95%-250p

EN 61000-3-2 Class A

EN 61000-3-3



USA, Friday, May 15, 2009
Kenneth Stuart Hansen, Compliance Engineer

Product Modification Warning

High End Systems products are designed and manufactured to meet the requirements of United States and International safety regulations. Modifications to the product could affect safety and render the product non-compliant to relevant safety standards.

Mise En Garde Contre La Modification Du Produit

Les produits High End Systems sont conçus et fabriqués conformément aux exigences des règlements internationaux de sécurité. Toute modification du produit peut entraîner sa non conformité aux normes de sécurité en vigueur.

Produktmodifikationswarnung

Design und Herstellung von High End Systems entsprechen den Anforderungen der U.S. Amerikanischen und internationalen Sicherheitsvorschriften. Abänderungen dieses Produktes können dessen Sicherheit beeinträchtigen und unter Umständen gegen die diesbezüglichen Sicherheitsnormen verstoßen.

Avvertenza Sulla Modifica Del Prodotto

I prodotti di High End Systems sono stati progettati e fabbricati per soddisfare i requisiti delle normative di sicurezza statunitensi ed internazionali. Qualsiasi modifica al prodotto potrebbe pregiudicare la sicurezza e rendere il prodotto non conforme agli standard di sicurezza pertinenti.

Advertencia De Modificación Del Producto

Los productos de High End Systems están diseñados y fabricados para cumplir los requisitos de las reglamentaciones de seguridad de los Estados Unidos e internacionales. Las modificaciones al producto podrían afectar la seguridad y dejar al producto fuera de conformidad con las normas de seguridad relevantes.

FCC Information

This equipment has been tested and found to comply with the limits for a Class A digital device, pursuant to part 15 of the FCC rules. These limits are designed to provide reasonable protection against harmful interference when the equipment is operated in a commercial environment. This equipment generates, uses, and can radiate radio frequency energy and, if not installed and used in accordance with the instruction manual, may cause harmful interference to radio communications. Operation of this equipment in a residential area is likely to cause harmful interference, in which case the user will be required to correct the interference at his own expense.

Important Safety Information

Instructions pertaining to continued protection against fire, electric shock, and injury to persons are found in Appendix E. Please read all instructions prior to assembling, mounting, and operating this equipment.

Important: Informations De Sécurité

Les instructions se rapportant à la protection permanente contre les incendies, l'électrocution, excessif et aux blessures corporelles se trouvent dans l'Annexe E. Veuillez lire toutes les instructions avant d'assembler, de monter ou d'utiliser cet équipement.

Wichtige Sicherheitshinweise

Sicherheitsanleitungen zum Schutz gegen Feuer, elektrischen Schlag, und Verletzung von Personen finden Sie in Anhang E. Vor der Montage, dem Zusammenbau und der Inbetriebnahme dieses Geräts alle Anleitungen sorgfältig durchlesen.

Informazioni Importanti Di Sicurezza

Le istruzioni sulla protezione da incendi, folgorazione, e infortuni sono contenute nell'appendice E. Si prega di leggere tutte le istruzioni prima di assemblare, montare e azionare l'apparecchiatura.

Informacion Importante De Seguridad

En el Apéndice E se encuentran instrucciones sobre protección continua contra incendios, descarga eléctrica, y lesiones personales. Lea, por favor, todas las instrucciones antes del ensamblaje, montaje y operación de este equipo.

Symbols

The following international caution and warning symbols appear in margins throughout this manual to highlight messages.



CAUTION: This symbol appears adjacent to Caution messages. Not heeding these messages could result in personal injury and/or damage to equipment.



WARNING: This symbol appears adjacent to high voltage warning messages. Not heeding these messages could result in serious personal injury.



This symbol indicates the minimum distance from a lighted object

Warranty Information

Limited Warranty

Unless otherwise stated, your *product* is covered by a one year parts and labor limited warranty. It is the owner's responsibility to furnish receipts or invoices for verification of purchase, date, and dealer or distributor. If purchase date cannot be provided, date of manufacture will be used to determine warranty period.

Returning an Item Under Warranty for Repair

It is necessary to obtain a Return Material Authorization (RMA) number from your dealer or point of purchase BEFORE any units are returned for repair. The manufacturer will make the final determination as to whether or not the unit is covered by warranty.

Any Product unit or parts returned to High End Systems must be packaged in a suitable manner to ensure the protection of such Product unit or parts, and such package shall be clearly and prominently marked to indicate that the package contains returned Product units or parts and with an RMA number. Accompany all returned Product units or parts with a written explanation of the alleged problem or malfunction. Ship returned Product units or parts to: 2105 Gracy Farms Lane, Austin, TX 78758 USA.

Note: Freight Damage Claims are invalid for fixtures shipped in non-factory boxes and packing materials.

Freight

All shipping will be paid by the purchaser. Items under warranty shall have return shipping paid by the manufacturer only in the Continental United States. Under no circumstances will freight collect shipments be accepted. Prepaid shipping does not include rush expediting such as air freight. Air freight can be sent customer collect in the continental United States.

REPAIR OR REPLACEMENT AS PROVIDED FOR UNDER THIS WARRANTY IS THE EXCLUSIVE REMEDY OF THE CONSUMER OTHER THAN THE LIMITED WARRANTY STATED ABOVE. HIGH END SYSTEMS, INC. MAKES NO WARRANTIES, EXPRESS OR IMPLIED, WITH RESPECT TO ANY PRODUCT, AND HIGH END SPECIFICALLY DISCLAIMS ANY WARRANTY OF MERCHANTABILITY OR FITNESS FOR A PARTICULAR PURPOSE. HIGH END SHALL NOT BE LIABLE FOR ANY INDIRECT, INCIDENTAL OR CONSEQUENTIAL DAMAGE, INCLUDING LOST PROFITS, SUSTAINED OR INCURRED IN CONNECTION WITH ANY PRODUCT OR CAUSED BY PRODUCT DEFECTS OR THE PARTIAL OR TOTAL FAILURE OF ANY PRODUCT REGARDLESS OF THE FORM OF ACTION, WHETHER IN CONTRACT, TORT (INCLUDING NEGLIGENCE), STRICT LIABILITY OR OTHERWISE, AND WHETHER OR NOT SUCH DAMAGE WAS FORESEEN OR UNFORESEEN.

Warranty is void if the product is misused, damaged, modified in any way, or for unauthorized repairs or parts. This warranty gives you specific legal rights, and you may also have other rights specific to your locality.

Table of Contents

SHOWPIX® Pixelation Luminaire User Manual	i
Contacting High End Systems®	ii
Patents	ii
Declaration of Conformity	iii
Product Modification Warning	iv
FCC Information	iv
Important Safety Information	iv
Symbols	v
Warranty Information	v

Chapter 1: Product Overview

This chapter describes the features of the SHOWPIX® Pixelation Luminaire with Stock content and Echo software.

Features	1
System	1
Graphics Engine	2
Operation	2
Construction	3
Echo Software	3
Related Products and Accessories	3
Specifications	4
Mechanical Specifications	4
Mounting Information	5
Electrical/Light Source Specifications	5
Operation	5

Chapter 2: Setup and Configuration

SHOWPIX® fixture setup includes mounting, connecting to power and DMX linking and configuration.

Unpacking the Fixture	7
Pan and Tilt Locking	7
Installing a Power Cord Cap	8
Installing a Line Cord Cap - U.K. Only	8
Vatic Fitter Heads Information - Danmark	8
Mounting the Fixture	9
Mounting the Fixture Upright	9
Truss Mounting	9
Side Mounting and Angular Mount on Moving Truss	10
Linking SHOWPIX Fixtures	11
Cable Connectors	11
Connecting to the Link	12

Powering On the Fixture	12
Setting the DMX Start Channel	13
Shutting Down the Fixture	14
Placing Fixture in Road Case	14

Chapter 3: SHOWPIX® Menu System

The onboard Menu system provides fixture configuration options. This chapter shows you how to access and navigate the Menu System, the options available at each Menu level, and includes examples.

Navigating the Menu System	15
The SHOWPIX® Display	15
Navigational Basics	16
Display in Menu Locked Mode	16
Fixture Software Version	16
DMX Start Channel	16
Error Message Display	16
Unlocking the Menu System	16
Exiting the Menu System	17
Menu Map	17
Menu System Options	21
DMX Address Menu	21
Setting DMX Start Channel	21
Set Parameters Menu	22
Factory Default Settings	22
Pan/Tilt Swap	22
Pan Invert	23
Tilt Invert	23
Data Loss Timeout	24
Display Level	24
Fixture Mode Menu	25
Crossloading Fixture Software	25
Protocol Mode	25
Test Options Menu	26
Homing the Fixture	26
Copying the Boot Code	26
Self Test	26
Display Test	26
Encoder Disable	26
Code Menu	26

Information Menu	27
Sensor Status Menu	27
Unique Number	27
DMX Values Menu	27
Temperatures Menu	28
Fixture Hours	29
Fixture Hours Reset	29
Software Version	29
Module Version	29
Display Errors	29
Channels Needed	30
Next DMX Channel	30

Chapter 4: DMX Programming Basics and Quick Start

If you are new to DMX programming, this chapter will give you a brief overview on programming SHOWPIX® and StudioPix™ fixtures followed by an example using a Wholehog console to patch and display output.

DMX Programming Overview	31
DMX512 Links	31
8-bit vs. 16-bit DMX Parameters	31
Determining a DMX Start Channel	32
SHOWPIX and StudioPix Protocol Modes	33
Standard Protocol	33
Standard Protocol Table for SHOWPIX and StudioPix	33
RGB Reduced Protocol	34
RGB Reduced Protocol Table for SHOWPIX and StudioPix	34
Pixel Mapping Protocol	35
SHOWPIX Pixel Mapping Table	35
StudioPix Pixel Mapping Table	36
Extended Protocol	37
SHOWPIX and StudioPix Fixtures Extended Protocol Table	37
Lighting Console Tips	38
Fixture Libraries:	38
Patching SHOWPIX and StudioPix Fixtures Using the Standard Protocol	38
Patching SHOWPIX and StudioPix Fixtures in Other Protocol Modes	38
Reduced Mode	38
Pixel Mapping Mode	38
Enhanced Mode	39
DMX Output Displays	39
Pixellage Content Playback	39
Wholehog Programming Notes	39
Play Modes (Intensity)	39
CMY	39
Custom Wheel Sets	39
Quick Start with a Wholehog Console	40

Chapter 5: Fixture Control

This chapter describes mechanical movement control for SHOWPIX™ and StudioPix™ fixtures in all protocol modes.

Pan and Tilt	41
MSpeed (Motor Speed)	41
Macros	42
Control Function Options	42

Chapter 6: Color Control

The Standard protocol modes for SHOWPIX and StudioPix fixtures provide color mixing control for up to two image files and a composite image. Other protocol modes provide washlight operation or individual LED color mixing.

Color Parameters	43
Color Function Parameter	44
Color Function Descriptions	45
Add Color to Black	45
Black and White	45
Black and White Inverted	45
CMY	45
Color Cycle	46
Compress to Maximum	46
Rainbow Color Cycle	46
Random Color	47
Replace Background Color	47
RGB Add non-black pixels	47
RGB Add, All Pixels	47
RGB Invert & Swap to BRG	48
RGB Invert & Swap to GBR	48
RGB Invert	48
RGB Swap to BGR	49
RGB Swap to BRG	49
RGB Swap to GBR	49
RGB Swap to GRB	50
RGB Swap to RBG	50
Scale	50
Solarize	51
Solarize 1	51
Solarize 2	51
Solarize 3	51
Solarize 4	51
Transparent Color	51
Background Color	52

Chapter 7: Global Control

Global controls affect the composite image created when you define two Image layers.

Dim	53
Strobe	53
Scale	54
Rotate	54
Dampening	55
Global Transition	55
Global Effects	55

Chapter 8: Global Control: Transitions

The Transition Mode and Transition parameters provide over 70 patterns for switching between image layers and interact with the Color Transparency parameter to create a wide range of looks.

Transition Types	57
Opacity Transitions	57
Normal Fade	57
Fade Through Black	58
Reveal Transitions	59
Overlay Transitions	60
Transition Mode Parameter	60
Transition Parameter	63
Transitions and Color Transparency	63
Transparency with Opacity Transitions	63
Transparency with Reveal Transitions	63
Transparency with Overlay Transition	64

Chapter 9: Image Graphics Control

You can apply a variety of color mixing options, transitions and effects to each individual Image layer in Standard or Enhanced protocol modes.

Defining Content	65
Media Folder	65
Media Folder Descriptions	66
Media File	66
Frame	67
DMX Scratch™	67
Playback Mode	68
Playback Speed	68
Rotation	69
Scale Parameter	70

Changing Image Position	71
X Position Parameter	71
Y Position Parameter	71
Image Transition	72
Transition Mode	72
Transition Speed	72
Effect Function	73
Pixel Mapping	73
Appendix A: MSpeed Conversion Table	75
Appendix B: Important Safety Information	77
Appendice B: Importantes Informations Sur La Sécurité	78
Anhang B: Wichtige Hinweise Für Ihre Sicherheit	79
Apéndice B: Información Importante De Seguridad	80
Appendice B: Importanti Informazioni Di Sicurezza	81
Vigtig Sikkerhedsinformation	82

Chapter I

Product Overview

This chapter describes the features of the SHOWPIX® Pixelation Luminaire with Stock content and Echo software.

The SHOWPIX® Pixelation Luminaire is a combination wide angle LED wash light on a moving yoke and a high power display device viewed directly by an audience.

The 18-inch diameter head features a circular LED array with an output of 24,000 RGB lumens. In addition to displaying washes of color, SHOWPIX utilizes an internal graphics engine to provide graphic control of two images.

SHOWPIX is equipped with a Stock Content collection of over 400 images including animations designed specifically for the product. You can easily upload your own files (up to 256) and images through the **Echo™** application, a software program offering content visualization, management and upload capabilities as well as RDM management features. Echo converts many file formats, automatically optimizes the images, maps the files to the SHOWPIX display and allows you to preview this mapping on your computer prior to uploading to the SHOWPIX fixture.

The **DMX Scratch™** feature lets you synchronize the frames of a media file to music during a show in real time.

With the **Pixellage™** effect, you can map content across numerous SHOWPIX fixtures to allow for full stage imagery.

SHOWPIX provides multiple protocol choices for a wide range of DMX control.

Features

System

- Internal Graphics Engine
- 127 individually controlled RGB LED pixels
- Echo Content Management and Configuration software can remotely manage multiple SHOWPIX fixtures
- Remote software upgrade capability
- Supports importing of custom content including media files and still images
- High End Systems stock content featuring over 400 custom created images

Graphics Engine

Standard protocol provides:

- Simultaneous playback of two discrete media streams
- 17 parameters give you graphic controls for each individual media stream including:
 - a choice of multiple play modes and play speeds
 - the ability to play a single frame or entire media stream
 - multiple color mixing and visual effects that can be combined any way you choose
 - full control of image rotation, positioning and scaling
 - adjustable frame to frame transitions
 - independent control of background colors
 - transparent color definitions allow combining of media images
 - dynamic visual effects
- 12 global parameters provide controls to the composite image created by 2 media streams
 - transition mode provides unique wipes and transitions between media streams
 - intensity control to provide system-wide intensity level
 - strobe control to provide system-wide strobe rate
 - overall image color mixing applied to composite media stream image
 - overall image scale and rotation
 - system wide visual effects

Optional protocol modes adapt SHOWPIX DMX control for variable programming styles

- RGB Reduced protocol uses 12 channels for full motion and washlight color mixing
- Pixel Mapping protocol provides individual RGB control of each of the 127 LEDs
- Extended protocol combines all the features of Standard and Pixel Mapping protocol

Operation

- 400° pan and 240° tilt movement
- 24,000 RGB Lumen output
- Auto-switching power supply
- Large dot matrix display allows for 2 lines of text
- 100v-230v power input
- 5-pin XLR DMX connectors
- ETL and CE Compliant

Construction

- Modular construction
- Homogenized RGB LED array creates smooth a color output
- Electronic cooling system control
- Fast, smooth and quiet yoke movement using proprietary multi-phase technology
- Performance oriented exterior design
- Pan and tilt locks for easy transportation

Echo Software

- Imports a wide variety of movie and graphic files and converts them to SHOWPIX format with a preview
- Provides options for assigning DMX values to folders and files
- Lets you develop content packages and transport them to other locations
- Uploads fixture software
- Clones content
- Creates and manages Pixellation content

Related Products and Accessories

The following table lists related products and accessories available for the SHOWPIX fixture. For more information, contact your High End Systems dealer/distributor (see *Contacting High End Systems®* on page ii).

Part Description	Part Number
Wholehog single USB DMX widget	74040002
USB upload module	74040006
SHOWPIX Roadcase	A4070001
5-amp, slow-blow fuse	90403012
Wholehog 3 lighting console	61020003
Road Hog lighting console	A2020001
Road Hog Full Boar lighting console	A6020001
Galvanized safety cable	12040001
Mega-Claw clamp	67040007
Male 5-pin DMX terminator	90404039
Heavy duty 5-pin XLR cable (10')	55050017
Heavy duty 5-pin XLR cable (25')	55050018
Heavy duty 5-pin XLR cable (50')	55050019
Heavy duty 5-pin XLR cable (100')	55050020

Specifications

Mechanical Specifications

Fixture Dimensions: 594 mm x 522 mm x 840 mm (23.4 in x 20.6 in x 33 in)

Fixture Weight: 49 kg (108 lbs)

Roadcase Dimensions: 711 mm x 648 mm x 1054 mm (28 in x 25.5 in x 41.5)

Shipping Weight (Roadcase + Fixture): 104.3 kg (230 lbs)

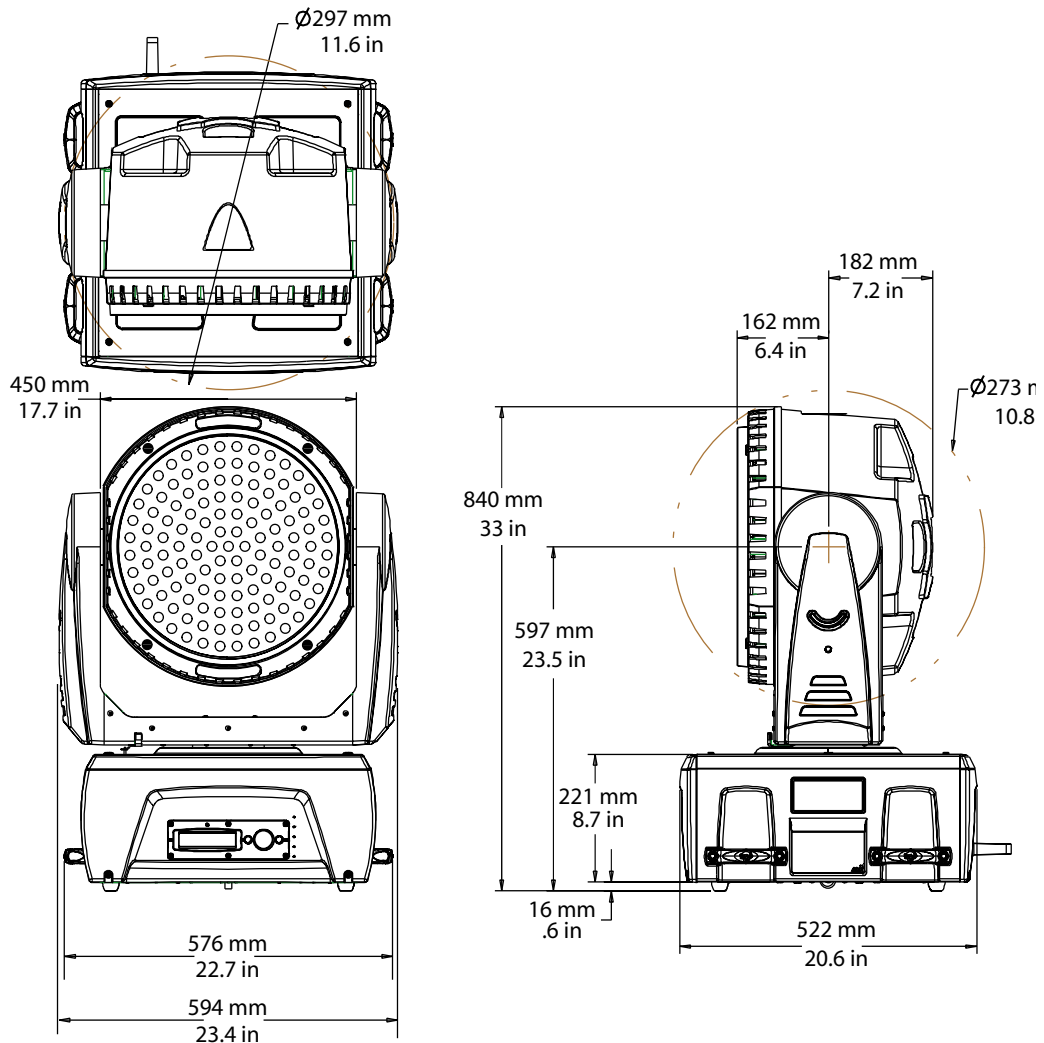

Mounting Information

The SHOWPIX fixture can be truss-mounted using 1/4 camlock c-clamps or style pole mounting brackets. It can also stand upright on a stable surface.

Electrical/Light Source Specifications

Input ratings: 100-230 VAC; 50-60 Hz; 12-5A

LED Array: 127 3-watt RGB LEDs with homogenizing system

Output: 24,000 RGB lumens

Note: RGB lumens are calculated by comparing the combined energy levels of SHOWPIX WRGBCMY to a theatrical metal halide color changing fixture and creating a factor.

Beam angle: 45°

Field angle: 80°

Color mixing: RGB

Operation

Pan: 400°, **Tilt:** 240°

Control: DMX 512

Minimum distance from lighted object: 1 meter (3.9 ft.)

Compliances: CE, CSA, ETL

Peripheral/Network Connectors: One USB port for uploading to the fixture directly from a computer

DMX connectors: 5-pin male and female XLR connectors

Environmental tolerances: Maximum ambient operating temperature 50° C (122° F); maximum exterior surface temperature 70° C (158° F)

Software upgrades: Download operating software and Echo software from the High End Systems website (www.highend.com)

Chapter 2

Setup and Configuration

SHOWPIX® fixture setup includes mounting, connecting to power and DMX linking and configuration.

Use the following steps to set up and configure your SHOWPIX® fixture:

1. Unpack the fixture.
2. Install power cord cap for your location.
3. Mount the fixture upright or suspended from a standard truss.
4. Connect the fixture to a DMX controller via DMX cabling.
5. Connect the fixture to power.
6. Configure the fixture for DMX control.

Unpacking the Fixture

The SHOWPIX® fixture is transported in a shipping box or road case specifically designed to protect the product during transport. When unpacking, inspect the fixture for physical damage to components. High End Systems® assumes no responsibility for products that are damaged during transport. Return a product for repair in its shipping box or road case. Before sending anything to the factory, call your High End Systems dealer/distributor for a Return Material Authorization (RMA) number. The factory cannot accept any goods shipped without an RMA number.

Pan and Tilt Locking

The SHOWPIX fixture ships with pan and tilt latches locked. You can unlock/adjust these latches to stabilize the fixture for mounting and re-packing in a roadcase.

Note: *Disengage the Pan and Tilt locks before operating the fixture.*

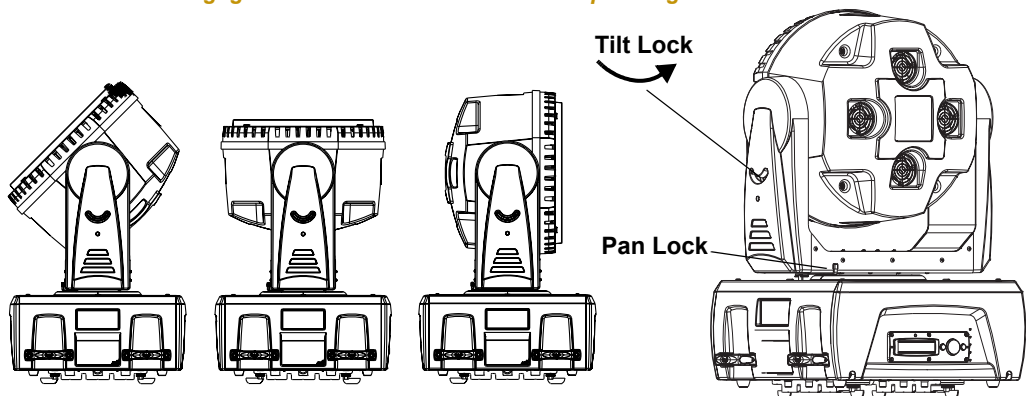

Installing a Power Cord Cap

The SHOWPIX® fixture's custom power cord ships without a power cord cap. Use the information in this section to install the correct power cord cap for your location.

Because of the variety of power cord caps used worldwide, High End Systems, Inc. cannot make specific recommendations for the power cord cap. Contact a local authority for the type of power cord cap needed. When installing the power cord cap, note that the cores in the mains lead are colored according to the following code:

- green and yellow = earth
- blue = neutral
- brown = live

Installing a Line Cord Cap - U.K. Only

In the United Kingdom, core colours in the mains lead of this equipment may not correspond with the colored markings identifying the terminals in the fixture's plug. In that case, install a line cord cap according to the following code:

- Connect the green and yellow core to the plug terminal marked with the letter "E," or by the earth symbol  or coloured green, or green and yellow.
- Connect the blue core to the terminal marked with the letter "N" or coloured black.
- Connect the brown core to the terminal marked with the letter "L" or coloured red.



WARNING:
Class 1 equipment - This equipment must be earthed.

Vatic Fitter Heads Information - Danmark

Advarsel: Beskyttelse mod elektrisk chock.

Vigtigt!

Lederne med gul/groen isolation maa kun tilsluttes en klemme maerket



eller



Mounting the Fixture

You can mount your SHOWPIX® fixture suspended from a support system (such as a truss) or freestanding on its base.



WARNING!

Equipment suitable for dry locations only. Do not expose this equipment to rain or moisture.



CAUTION!

SHOWPIX fixtures must be installed and operated by trained personnel only.

Always use a secondary safety cable when mounting this fixture.



Maintain a minimum focus distance of 1 meter from a lighted object.

Note: Due to the wide variety of possible lighting designs, High End Systems cannot make specific mounting recommendations. Consider the following procedure as a suggested guideline only.

Mounting the Fixture Upright



CAUTION!

Do not mount the fixture upright without the four rubber feet attached.

To mount the fixture upright:

1. Place the fixture on a sturdy, stable non-flammable surface that will support more than the 49 kg (108 lb) weight of the SHOWPIX® fixture. If the surface is above floor height, use safety cables to secure the fixture to the surface.
2. Disengage Pan and Tilt locks before powering on the fixture.

Truss Mounting

When mounting the fixture on a truss or another type of support:

- Verify the truss or support will handle the combined weight of all the devices on the truss.
- Always mount the SHOWPIX fixture using the mounting bracket assembly that shipped with your fixture and a safety cable attached to the fixture's base.



WARNING!

Before mounting, disconnect power to the fixture. If it has been operating, allow the fixture to cool for five minutes before handling.



CAUTION!

Do not use C- Clamps to mount the SHOWPIX fixture to truss.

Use the following steps to mount a SHOWPIX fixture on a standard truss:

1. Due to its size and weight, at least two people should support the fixture while another attaches clamps and safety cables. Always stand on a firm, stable surface when mounting a fixture to its support.
2. Fixtures shipping in a road case will have clamps mounted to the base. If you received the fixture in a shipping box, you will need to mount the clamps that shipped with fixture to the mounting brackets and then attach the two mounting brackets to the base of the fixture using the provided quarter-turn screws.

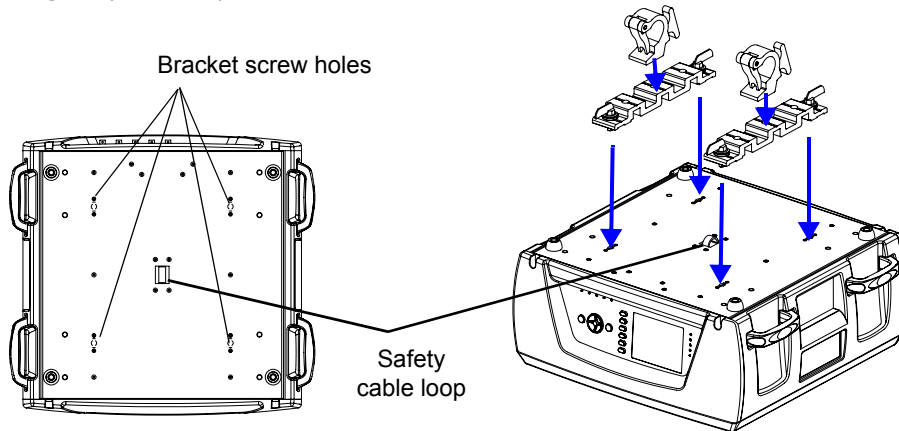

3. Tighten the clamps firmly to the fixture's base and to the support.
4. Run the safety cable through the loop on the fixture's base, and around the truss.
5. Disengage Pan and Tilt locks before powering on the fixture.

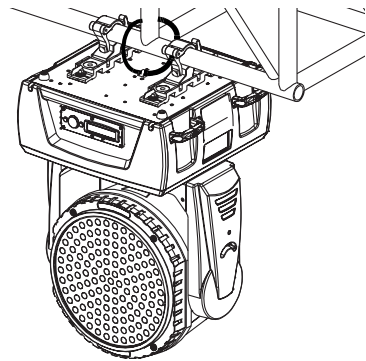

Side Mounting and Angular Mount on Moving Truss

For fixtures in a side mount or at an acute Angular orientation, set the Outrig Mode on the DMX console.

When side mounting a SHOWPIX fixture, orient the unit as show on the right with the Display panel up or down perpendicular to the floor.

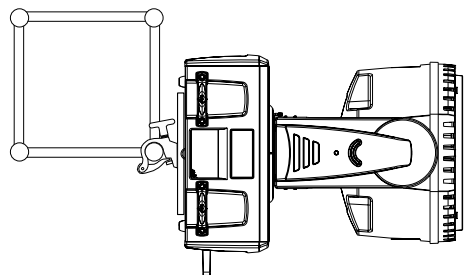

Linking SHOWPIX Fixtures

SHOWPIX fixtures operate on a standard DMX512 link controlled by a DMX console. The number of fixtures on a link will be determined by the combined number of channels required by all the fixtures. A SHOWPIX fixture using Standard protocol requires 70 channels on a DMX512 link. Attach the fixture to the link using data-grade cable and 5-pin XLR cable connectors.

Cable Connectors

The SHOWPIX fixture accepts 5-pin XLR cable connectors. Cabling must have a male XLR connector on one end of the cable and a female XLR connector on the other end.

Pin one is the common (cable shield), pin two is the data complement (negative), pin three is the data true (positive). Pins four and five are not used, but they allow a secondary data link to pass through the fixture.

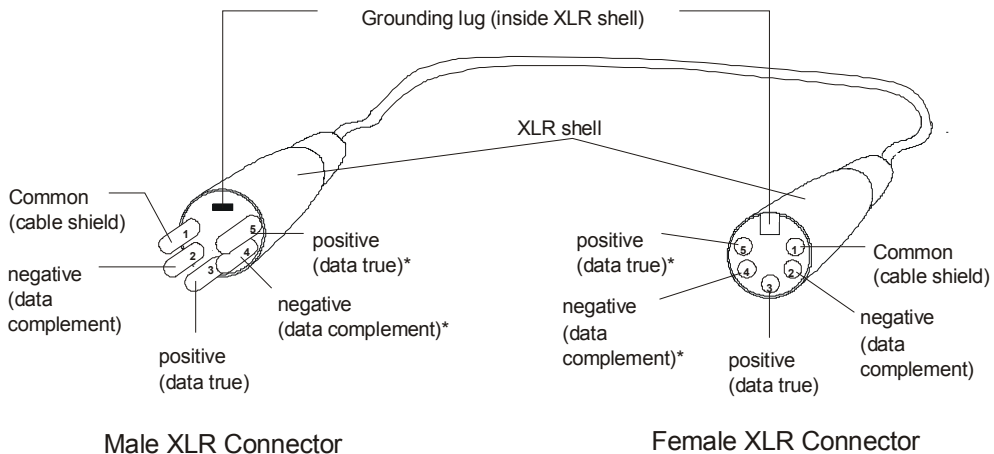

Male XLR Connector

Female XLR Connector

**This data line is not used by the fixture, but allows data to pass through the fixture.*

Test each cable with a voltage/ohm meter (VOM) to verify correct polarity and to make sure that the negative and positive pins are not grounded or shorted to the shield or to each other.



CAUTION!

Do not connect anything to the ground lug on the XLR connectors. Do not connect or allow contact between the common (cable shield) and the fixture's chassis ground. Grounding the common could cause a ground loop and/or erratic behavior.

Connecting to the Link

To link one or more fixtures to a DMX controller:

1. Connect the male XLR connector of a DMX Data cable to the controller's DMX Data Out connector.
2. Connect the Data cable's female XLR connector to the Data In connector of the first (or next) fixture on the DMX link.
3. Continue linking the remaining fixtures connecting a cable from the Data Out connector of each fixture to the Data In connector of the next fixture on the link.

4. Terminate the link by installing a 120 ohm, 1/4 watt (minimum) terminator in the fixture's Data Out (female) cable connector in the last fixture on each DMX link. A terminator on the last fixture of the link prevents data reflection, which can corrupt the data communication on the link.

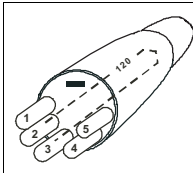

To construct a terminator:

1. Disassemble a male 5-pin XLR connector.
2. Solder a 120 ohm resistor, minimum of 1/4 watt, between Pin 2 and Pin 3.

Powering On the Fixture



WARNING:

This equipment is designed for connection to a branch circuit having a maximum overload protection of 20 A.



CAUTION:

Do not power on the fixture until *verifying* that the line cord cap is suitable for the power source in your location. For more information, see *Installing a Power Cord Cap* on page 8.

Disengage the Pan and Tilt locks before operating the fixture, see *Pan and Tilt Locking* on page 7.

To power on the SHOWPIX fixture, simply connect it to a 100-230 V AC power source.

Once the SHOWPIX fixture is connected to a power source, it automatically begins a homing procedure to verify the major functions of the fixture.

Setting the DMX Start Channel

Each SHOWPIX fixture requires a block of consecutive channels on a 512-Channel DMX link. The number of channels depends on the Protocol you are using.

To set the Start Channel on an SHOWPIX Fixture:

1. Access the fixture's menu system via the dot matrix display on the fixture's front panel. For a detailed description of the menu system, see *Chapter 3: SHOWPIX® Menu System* on page 15.

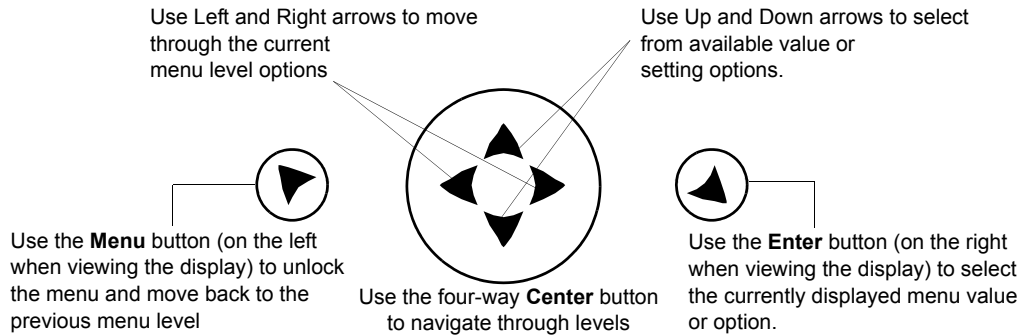

Note: *Navigation system buttons' functions invert automatically when the fixture is turned upside down.*

2. Unlock the menu system by pressing and holding down the **Menu** button until the extended 2-line display appears. DMX Address menu is the first option at the top menu level.
3. Press the **Enter** button to select. The display will show Set DMX Start Channel:###. The display will show the start channel currently assigned to the fixture.
4. Use the Up and Down arrow buttons on the **Center** button to select a new DMX start channel. The display will flash a new option ready for selection.

SHOWPIX Protocol Mode	DMX Channel Range	Last Valid Start Channel
Standard Protocol	70	442
RGB Reduced Protocol	12	501
Pixel Mapping Protocol	390	123
Extended Protocol	451	62

5. Press the **Enter** button to store the new DMX Start channel. The display will stop flashing when a new option is entered.

When setting the Start channel on a fixture, remember:

- A fixture's physical location on the link does not have to coincide with the order of channel range assignments in the link.

- The fixture's channel range must not overlap any other device's channel range on the link. When two devices on the same DMX link have overlapping channel ranges, one or both devices will be disabled or behave erratically. The single exception would be if two or more fixtures need to respond to controller commands in exactly the same way. In that case, those fixtures must be the same type and must share the *entire* channel range.

Shutting Down the Fixture

A DMX controller can shut down the fixture remotely with the Shutdown option in the Control Channel or you can simply disconnect from power.

The SHOWPIX fixture automatically shuts down in the event of DMX data loss longer than five minutes.

Placing Fixture in Road Case

Before shipping the SHOWPIX fixture, lock the pan and tilt position so the fixture does not move during transit.

To lock the fixture:

1. Orient the projector head pan position as shown for packing in the road case and secure with the pan lock located on the yoke base.

Note: *This is the only pan position that locks.*

2. Move the tilt lock peg to the upper left (locked) position.
3. Gently move the projector head and yoke to verify that both pan and tilt positions are locked in place.
4. Place the SHOWPIX fixture in the road case as shown for shipping.

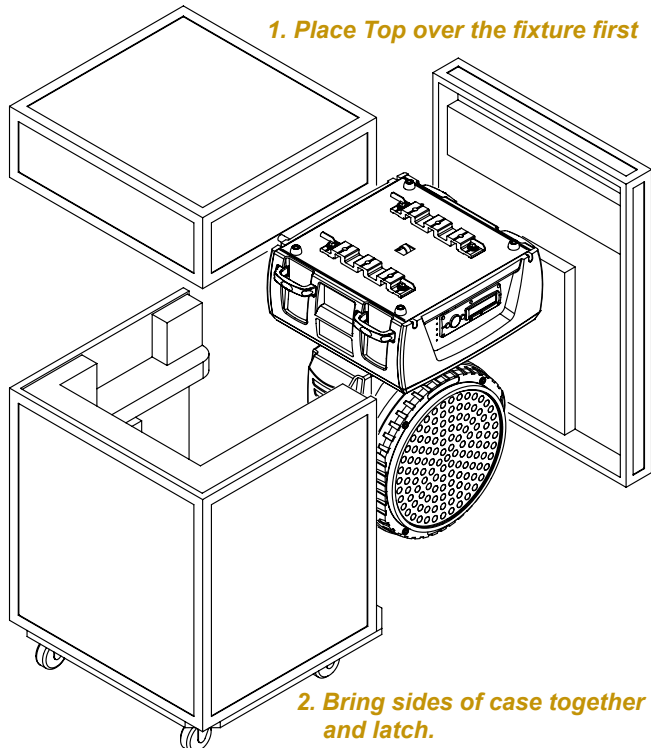
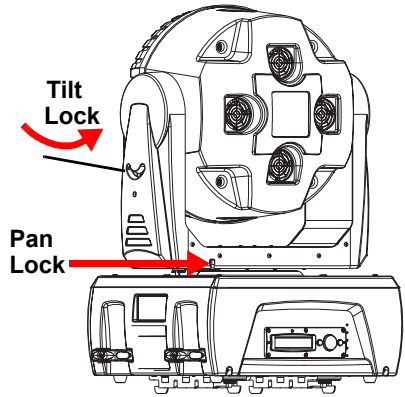

Chapter 3

SHOWPIX® Menu System

The onboard Menu system provides fixture configuration options. This chapter shows you how to access and navigate the Menu System, the options available at each Menu level, and includes examples.

Navigating the Menu System

The onboard Menu system lets you perform the following functions at the fixture level:

- Assign a DMX start channel
- Access and set fixture options
- View fixture status
- Crossload software between fixtures

The SHOWPIX® Display

The front panel on SHOWPIX fixtures has a dot matrix display and six arrows on navigation. This display reduces the menu levels required and dramatically increases usability with the capability of displaying up to two 16-character lines of text.

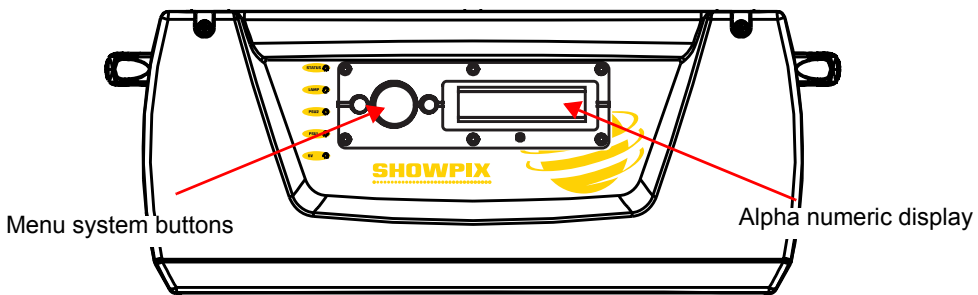

The SHOWPIX fixture can sense orientation and automatically inverts the display and the Center button's functions when the fixture is mounted upside down.

Use Left and Right arrows to move through the current menu level options

Use Up and Down arrows to select from available value or setting options.

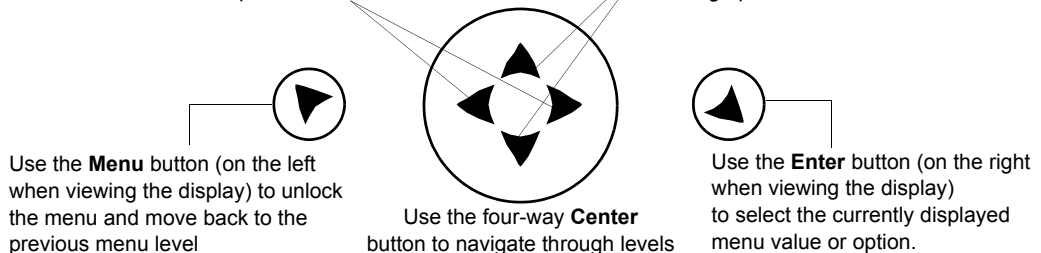

Navigational Basics

1. Unlock the Menu system by pressing the **Menu** ▼ button for a few seconds until the display goes to the 2-line format.
2. Use the left and right arrows ◀▶ on the **Center** button to scroll through menu options at the current level.
3. Stop at the desired menu and press the **Enter** ▲ button to select.

Note: *The new option will not be stored unless the Enter button is pressed.*

4. If there is another level of menu choices repeat Steps 2 and 3.
5. At the option or setting level of the menu, use the Up and Down arrows ▲▼ on the **Center** button to scroll to the desired option or setting. The option flashes until the **Enter** button is pressed. Pressing the **Enter** button stores the new value for that option. Pressing the **Menu** button returns to the previous menu level *without changing* the value of an option.
6. Continue pressing the **Menu** button to move back up levels until exiting the Menu system.

Display in Menu Locked Mode

The SHOWPIX display panel gives access to the fixture's onboard Menu System. When the Menu System is in locked mode, the panel displays in large 8-character format designed to be viewed from a distance. Under normal circumstances, when the display is locked, it cycles between displaying the SHOWPIX logo, the High End Systems logo, the fixture's software version [V##.##], and the fixture's DMX start channel [DMX_C###]. Any errors present are also displayed in an 8-character error description.

Fixture Software Version

The software version loaded on the fixture can vary even between units purchased at the same time. The latest software version is always posted on the High End Systems website (www.highend.com/support).

DMX Start Channel

The DMX Start Channel is the first channel currently assigned to that fixture in its range of channels on a DMX link. To reset the DMX start channel, see *Setting DMX Start Channel* on page 21. For more information on DMX Start channels, see *Determining a DMX Start Channel* on page 32.

Error Message Display

Errors are displayed in large 8-character form when the menu system is locked. Unlocked, the menu system's 2-line format displays more detailed information.

Unlocking the Menu System

To unlock the menu system, press and hold the **Menu** button until the display changes to the two-line format. You will need to hold the Menu button for a few seconds before the menu

unlocks to protect against an inadvertent menu change. DMX Address Menu is the first option on the top menu level.

Exiting the Menu System

To exit the menu system, keep pressing the Menu button to back out of each menu level until the High End Systems logo appears. The word AUTOLOCK will appear briefly on the display to indicate the fixture’s software is “locking” the display. The display switches back to the large 8-character format and, after a few seconds, begins the standard display for the locked mode as described above.

Menu Map

Level 1	Level 2	Level 3	Level 4	Option/Setting	Description/Notes
DMX ADDRESS MENU	SET DMX START CHANNEL: ###			1-483	Selected value becomes the first DMX value in the range for that fixture on a DMX 512 link.
SET MENU	FACTORY DEFAULT SETTINGS: ###			ON	Reverts fixture to default setting
				OFF	Indicates a factory default has changed
	PAN/TILT SWAP:			DISABLED	Restores default Pan and Tilt Motion
				ENABLED	Swaps the Pan and Tilt Motion
	PAN INVERT:			DISABLED	Restores default Pan motor direction
				ENABLED	Inverts Pan motor direction
	TILT INVERT:			DISABLED	Restores default Tilt motor direction
				ENABLED	Inverts Tilt motor direction
	DISPLAY LEVEL:			OFF	Dims Display when menu is locked
				ON	Turns display on
	DATA LOSS TIMEOUT:			SHORT	Fixture blacks out 1 second after data loss
				LONG	Fixture blacks out when fixture shuts down
FIXTURE MODE MENU	CROSSLoad FIRMWARE:			NO	Safe setting
				YES	Uploads fixture software to all other SHOWPIX fixtures on the link
	PROTOCOL MODE			STANDARD	Assigns the protocol type for DMX control
				ENHANCED	
				PIXEL MAP	
	REDUCED				

Level 1	Level 2	Level 3	Level 4	Option/Setting	Description/Notes	
TEST OPTIONS	HOME FIXTURE:			ALL	Homes all fixture functions	
	COPY BOOT:			NO	Does nothing when selected	
				YES	Copies boot code to fixture	
	SELF TEST	CHASSIS		PAN	Moves the head through the full pan range	
				TILT	Moves the head through the full tilt range	
	GRAPHICS ENGINE			RED	Turns all LEDs red	
				GREEN	Turns all LEDs green	
				BLUE	Turns all LEDs blue	
				PIXEL	Turns each individual LED on	
	DISPLAY TEST			OFF	Default Safe setting	
				ON	Performs Display test	
ENCODER TEST			OFF	Leaves encoders enabled		
			ON	Disables encoders		
CODE MENU					For factory use only	
INFORMATION MENU	SENSOR STATUS MENU			PAN	Displays absolute position of Pan	
				TILT	Displays absolute position of Tilt	
	UNIQUE NUMBER #####				Displays fixture's unique 10-character number	
	DMX VALUES MENU	BY CHANNEL		1:### ### ### 4:### ### ###	Displays current values for all channels in groups of six DMX values/screen	
		BY PARAMETER	CHASSIS PARAMETERS		DMX BREAKS	Displays the DMX Value for this parameter in the form: DMX ###
					DMX FRAMING ERR	
					DMX OVERRUN ERR	
					DMX START CHANNL	
					PAN COARSE	
					PAN FINE	
					TILT COARSE	
TILT FINE						
M-SPEED						
MACRO						
CONTROL						

Level 1	Level 2	Level 3	Level 4	Option/Setting	Description/Notes
INFORMATION MENU	DMX VALUES MENU	BY PARAMETER	GRAPHIC ENG PARAMETERS	STROBE	Displays the DMX Value for this parameter in the form: DMX ###
				DIM	
				COLOR FUNCTION	
				RED	
				GREEN	
				BLUE	
				SCALE	
				ROTATE	
				DAMPENING	
				TRANSITION MODE	
				TRANSITION	
				EFFECT FUNCTION	
				EFFECT MOD 1	
				EFFECT MOD 2	
			IMAGE A PARAMETERS	FOLDER	Displays the DMX Value for this parameter in the form: DMX ###
				FILE	
				FRAME	
				PLAY MODE	
				PLAY SPEED	
				SCALE	
				ROTATE	
				X POSITION	
				Y POSITION	
				COLOR FUNCTION	
				RED	
				GREEN	
BLUE					
TRANSPARENT					
BACKGROUND					
TRANSITION MODE					
TRANSITION SPEED					
EFFECT FUNCTION					
EFFECT MOD 1					
EFFECT MOD 2					

Level 1	Level 2	Level 3	Level 4	Option/Setting	Description/Notes	
INFORMATION MENU	DMX VALUES MENU	BY PARAMETER	IMAGE B PARAMETERS	FOLDER	Displays the DMX Value for this parameter in the form: DMX ###	
				FILE		
				FRAME		
				PLAY MODE		
				PLAY SPEED		
				SCALE		
				ROTATE		
				X POSITION		
				Y POSITION		
				COLOR FUNCTION		
				RED		
				GREEN		
				BLUE		
				TRANSPARENT		
				BACKGROUND		
	TRANSITION MODE					
	TRANSITION SPEED					
	EFFECT FUNCTION					
	EFFECT MOD 1					
	EFFECT MOD 2					
	TEMPERATURES MENU			CURRENT	TOPBOX	After selecting CURRENT, MAXIMUM or MINIMUM, you can view the temperature for the following sensors in degrees Centigrade: TOPBOX: ###C HEAD 1: ###C
					HEAD	
				MAXIMUM	TOPBOX	
					HEAD	
				MINIMUM	TOPBOX	
					HEAD	
				TEMP RESET	NO	
YES						
FIXTURE HOURS:				Displays fixture operation time in hours:minutes		
FIXTURE HOURS RESET:				NO	Default "safe" setting	
				YES	Press Enter for 5 seconds to reset fixture hours to 0	
SOFTWARE VERSION:				V ##.##.###	Status.Major.Minor.Build	

Level 1	Level 2	Level 3	Level 4	Option/Setting	Description/Notes
INFORMATION MENU	MODULE VERSION MENU			PAN HW:# SW:#	Displays the Hardware and Software versions for each logic board in the fixture.
				TILT HW:# SW:#	
				LED CPU CHAN 1 HW:# SW:#	
				LED CPU CHAN 2 HW:# SW:#	
				LED CPU CHAN 3 HW:# SW:#	
			DISPLAY ERRORS	Displays NOT AVAILABLE if a board does not exist in that position.	
	DISPLAY ERRORS MENU		XXXXXXXXXXXXX XXXXXXXXXXXXX		Scrolls through errors displayed in 2-line, 16-character format
	CHANNELS NEEDED:			##	Displays channel range for current Protocol selected (70 for SHOWPIX Standard Protocol)
	NEXT DMX CHANNEL:			##	(Current start channel + channels needed)

Menu System Options

The following sections describe and give examples for selecting and/or setting available menu options.

DMX Address Menu

DMX Address is the top level menu selection used to set the fixture's DMX start channel. Use this menu option, to change the *existing* DMX start channel to another DMX start channel.

Setting DMX Start Channel

To set the DMX start channel:

1. Press the **Menu** button to unlock the menu system or to move back up the system to the top level menus. DMX ADDRESS MENU is the first menu item at the top level.
2. Press the **Enter** button to select. The display will show SET DMX START CHANNEL:###. The display will show the start channel currently assigned to the fixture.
3. Use the up and down arrows on the **Center** button to select a new DMX start channel from 001– 483. The display will flash a new option ready for selection.

Note: *The last valid Start channel for a SHOWPIX fixture will depend on which protocol you have selected, see Determining a DMX Start Channel on page 32.*

4. Press the Enter button to accept the new DMX Start channel.

Note: *If the Enter button is not pressed, the old value will remain selected after exiting the menu.*

Set Parameters Menu

The Set Parameters menu sets all factory options to their default settings or changes the factory options individually.

Factory Default Settings

A SHOWPIX fixture ships with the following factory default settings:

Pan Tilt Swap=DISABLED	Tilt Invert=DISABLED	Protocol=STANDARD
Pan Invert=DISABLED	Display Level=ON	Data Loss Timeout=SHORT

If any of the default settings are changed, this menu reverts to the OFF option. The ON option restores all factory defaults.

To check and reset factory defaults:

1. Press the **Menu** button to unlock the menu system or to move back up the system to the top level menus.
2. Using the left and right arrows on the **Center** button, scroll through the top level to SET PARAMETERS MENU and press the Enter button to select.
3. Using the left and right arrows on the **Center** button, scroll to FACTORY DEFAULT SETTINGS. The current state (ON or OFF) will be displayed.
4. To reinstate the factory defaults if OFF is displayed, use the up and down arrows on the **Center** button to scroll to ON and press the **Enter** button to select.

Pan/Tilt Swap

This option swaps the pan motor and tilt motor operation to coordinate movements between fixtures on a link mounted perpendicular to each other.

To swap Pan and Tilt:

1. Press the **Menu** button to unlock the menu system or to move back up the system to the top level menus.
2. Using the left and right arrows on the **Center** button, scroll through the top level to SET PARAMETERS MENU and press the **Enter** button to select.
3. Using the left and right arrows on the **Center** button, scroll to PAN/TILT SWAP. The current state (ENABLED or DISABLED) will be displayed.
4. Use the up and down arrows on the **Center** button to scroll to ENABLED to swap pan and tilt or DISABLED to revert fixture to default setting and press the **Enter** button to select.

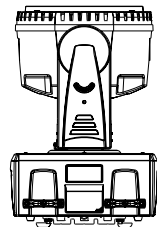
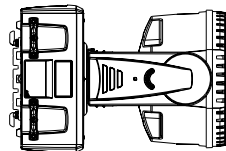

Pan Invert

This menu option inverts the direction of the pan motor to coordinate movements between fixtures mounted opposite each other horizontally.

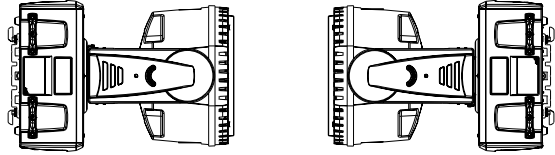

To invert the fixture's Pan motion:

1. Press the **Menu** button to unlock the menu system or to move back up the system to the top level menus.
2. Using the left and right arrows on the **Center** button, scroll through the top level to SET PARAMETERS MENU and press the **Enter** button to select.
3. Using the left and right arrows on the **Center** button, scroll to PAN INVERT. The current state (ENABLED or DISABLED) will be displayed.
4. Use the up and down arrows on the **Center** button to scroll to ENABLED to invert Pan movement or DISABLED to revert fixture to default setting and press the **Enter** button to select.

Tilt Invert

This menu option inverts the direction of the tilt motor to coordinate movements between fixtures on a link facing each other vertically.

To invert the fixture's Tilt motion:

1. Press the **Menu** button to unlock the menu system or to move back up the system to the top level menus.
2. Using the left and right arrows on the **Center** button, scroll through the top level to SET PARAMETERS MENU and press the **Enter** button to select.
3. Using the left and right arrows on the **Center** button, scroll to TILT INVERT. The current state (ENABLED or DISABLED) will be displayed.
4. Use the up and down arrows on the **Center** button to scroll to ENABLED to invert Tilt movement or DISABLED to revert fixture to default setting and press the **Enter** button to select.

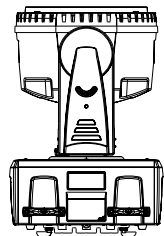
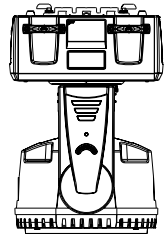

Data Loss Timeout

Use this menu option to determine how the fixture will react in the event of DMX data loss. Set the output to remain on until shutdown or to black out one second after data loss.

To set the DATA LOSS TIMEOUT:

1. Press the **Menu** button to unlock the menu system or to move back up the system to the top level menus.
2. Using the left and right arrows on the **Center** button, scroll through the top level to SET PARAMETERS MENU and press the **Enter** button to select.
3. Using the left and right arrows on the **Center** button, scroll to DATA LOSS TIMEOUT.
4. Using the up and down arrows on the **Center** button, choose LONG to keep the output active until shutdown, or SHORT to black out the fixture 1 second after data loss and press the **Enter** button to select.

Display Level

Use this menu option to Dim the display when the menu is locked.

To set the DISPLAY LEVEL:

1. Press the **Menu** button to unlock the menu system or to move back up the system to the top level menus.
2. Using the left and right arrows on the **Center** button, scroll through the top level to SET PARAMETERS MENU and press the **Enter** button to select.
3. Using the left and right arrows on the **Center** button, scroll to DISPLAY.
4. Using the up and down arrows on the **Center** button, choose OFF to dim the display or ON to turn the display on and press the **Enter** button to select.

Fixture Mode Menu

The Mode menu crossloads software from one fixture to other SHOWPIX fixtures on the link and selects the Protocol Mode for the fixture.

Crossloading Fixture Software

A fixture running a newer software version can load the new software to all other SHOWPIX fixtures on the link using the CROSSLOAD FIRMWARE menu option.

To CROSSLOAD FIRMWARE from one fixture to all SHOWPIX fixtures on the link:

1. Disconnect or bypass any controllers, serial data distributors, data line optoisolators, and any fixtures using RS-422 communications (such as Dataflash® AF1000 xenon strobes). These devices will block communication between the crossloading fixture and any other SHOWPIX fixtures on the link.
2. On the crossloading fixture *only*, unlock the menu system by pressing and holding down the **Menu** button until the extended 2-line display appears indicating the top menu level.
3. Using the left and right arrows on the **Center** button, scroll to the FIXTURE MODE MENU and press the **Enter** button to select.
4. Use the left and right arrows on the **Center** button to scroll to CROSSLOAD FIRMWARE.
5. Use the up and down arrows on the **Center** button to scroll to the YES option and press the **Enter** button to store. The fixture will upload its software to all other SHOWPIX fixtures on the link.

When the crossload has finished successfully, CROSSLOADING COMPLETE will appear briefly in the display of the crossloading fixture, and all other fixtures will automatically home.

Note: *If a new boot code was included with the latest software, the fixture displays a BOOTDIFF error when it returns to the locked mode of the menu system. To correct the boot code, copy the new boot code to each fixture (see Copying the Boot Code on page 26).*

Protocol Mode

SHOWPIX offers four protocol modes to support different application requirements.

To choose a PROTOCOL MODE:

1. Unlock the menu system by pressing and holding down the **Menu** button until the extended 2-line display appears indicating the top menu level.
2. Using the left and right arrows on the **Center** button, scroll to the FIXTURE MODE MENU and press the **Enter** button to select.
3. Use the left and right arrows on the **Center** button to scroll to PROTOCOL MODE.
4. Use the up and down arrows on the **Center** button to scroll to the STANDARD, REDUCED, PIXEL MAP or ENHANCED option and press the **Enter** button to store.

Test Options Menu

Homing the Fixture

The SHOWPIX fixture automatically homes all its functions whenever it is turned on. To manually home the fixture:

1. Press the **Menu** button to unlock the menu system or to move back up the system to the top level menus.
2. Use the left and right arrows on the **Center** button to scroll to the TEST OPTIONS MENU and press the **Enter** button to select.
3. Use the left and right arrows on the **Center** button to scroll to HOME FIXTURE.
4. Press the **Enter** button to store the selection. The fixture will begin homing.

Copying the Boot Code

When new software is uploaded to SHOWPIX fixtures, it may contain a new boot code which must be copied to each fixture. This is apparent if the fixture displays a BOOTDIFF error.



CAUTION:
Do not remove power from the fixture while performing a boot copy.

To accept and store the new boot code:

1. Press the **Menu** button to unlock the menu system or to move back up the system to the top level menus.
2. Using the left and right arrows on the **Center** button, scroll to the TEST OPTIONS MENU and press the **Enter** button to select.
3. Using the left and right arrows on the **Center** button, scroll to the COPY BOOT option and press the **Enter** button to select.
4. Use the up and down arrows on the **Center** button to scroll to the YES option and then press the **Enter** button to store the command. The fixture will store the new boot code, then automatically home.

Self Test

These options let you test pan and tilt functionality as well as the Graphic Engine control of LED color and operation.

Display Test

This option tests the functionality of the Menu Display screen.

Encoder Disable

This option lets you disable the encoders to prevent their function from interfering with manual rotation of the head.

Code Menu

This is a diagnostic option reserved for factory use.

Information Menu

The Information menu displays current fixture information such as internal temperature, fixture hours, hardware and software versions, DMX errors, and lets you view DMX data for this fixture and all devices on the DMX link. Fixture hours resets are also executed in the Information Menu.

Sensor Status Menu

The Sensor Status displays the current numeric position of the fixture's encoders. To view encoder values:

1. Press the Menu button to unlock the menu system or to move back up the system to the top level menus.
2. Use the left and right arrows on the **Center** button to scroll to the INFORMATION MENU and press the Enter button to select.
3. Use the left and right arrows on the **Center** button to scroll to the SENSOR MENU and press the Enter button to select.
4. Use the left and right arrows on the **Center** button to scroll to view PAN ENCODER or TILT ENCODER value.

Unique Number

Each SHOWPIX fixture has a unique number similar to a serial number. Navigate to this option to view the fixture's unique number.

DMX Values Menu

By Channel

This menu option lets you view the current DMX value for every channel on the DMX link that includes this fixture.

To help you navigate through all the channels on the link, the menu displays the values for Channels 001– 512 in two lines of three DMX values you can scroll through using the up and down buttons. The number at the beginning of each line indicates the first channel with a value displayed on that line. For example, line 1:### ### ### displays values for channels 1,2, and 3. Line 4:### ### ### displays values for channels 4, 5, and 6. To access the DMX VALUES MENU:

1. Press the **Menu** button to unlock the menu system or to move back up the system to the top level menus.
2. Use the left and right arrows on the **Center** button to scroll to the INFORMATION MENU and press the **Enter** button to select.
3. Use the left and right arrows on the **Center** button to scroll to the DMX VALUES MENU and press the **Enter** button to select.
4. Use the left and right arrows on the **Center** button to scroll to the DMX BY CHANNL and press the **Enter** button to select.
5. Use the up and down arrows scroll through the channel range.

By Parameter

This menu option lets you view the current DMX value for this fixture by parameter. The parameters are grouped as:

- Chassis parameters
- Graphic Engine parameters
- Image A parameters
- Image B parameters

Note: Viewing DMX values by Parameter will only be valid if you are using Standard Protocol.

Temperatures Menu

The SHOWPIX fixture contains temperature sensors that track current, maximum and minimum temperatures produced in the unit. Sensors monitor the air temperature of the electronics housing, and the fixture head.

Initially, the setting for current, maximum and minimum temperatures are equal. As the sensor detects temperature changes, the fixture adjusts the minimum and maximum settings.

To view maximum temperature the Head reached since the last reset:

1. Press the **Menu** button to unlock the menu system or to move back up the system to the top level menus.
2. Use the left and right arrows on the **Center** button to scroll to the INFORMATION MENU and press the **Enter** button to select.
3. Use the left and right arrows on the **Center** button to scroll to the TEMPERATURES MENU and press the **Enter** button to select.
4. Use the up and down arrows on the **Center** button to scroll to MAXIMUM. Press the **Enter** button to select and view the temperature recorded in degrees centigrade for the topbox and the head.

To reset all the temperature readings back to the current temperature:

1. Press the **Menu** button to unlock the menu system or to move back up the system to the top level menus.
2. Use the left and right arrows on the **Center** button to scroll to the INFORMATION MENU and press the **Enter** button to select.
3. Use the left and right arrows on the **Center** button to scroll to the TEMPERATURES MENU and press the **Enter** button to select.
4. Use the left and right arrows on the **Center** button to scroll to RESET TEMPERATURE. Press the **Enter** button to select. The display will read NO. Use the up and down arrow to scroll to YES and hold for 5 seconds to reset all sensors to the current temperature in centigrade.

Fixture Hours

Use this option to view the fixture operation time in hours and minutes.

Fixture Hours Reset

Use this option to reset the fixture operation time to Zero.

To access the FIXTURE HOURS RESET option:

1. Press the Menu button to unlock the menu system or to move back up the system to the top level menus.
2. Use the left and right arrows on the **Center** button to scroll to the INFORMATION MENU and press the Enter button to select.
3. Use the left and right arrows on the **Center** button to scroll to the FIXTURE HOURS RESET option and press the Enter button to select.
4. Use the up and down arrows on the **Center** button to scroll to YES. Press and hold the Enter button down for 5 seconds to select.

Software Version

This option display's the fixture's CPU board Software version. The version number is composed of: V(Major).(Minor).(Build).

Module Version

This option displays the current hardware and software versions for the following boards:

- Pan
- Tilt
- LED CPU Chan 1
- LED CPU Chan 2
- LED CPU Chan 3

Display Errors

This menu option displays current errors in a descriptive 32-character text field.

To DISPLAY ERRORS:

1. Press the **Menu** button to unlock the menu system or to move back up the system to the top level menus.
2. Use the left and right arrows on the **Center** button to scroll to the INFORMATION MENU and press the **Enter** button to select.
3. Use the left and right arrows on the **Center** button to scroll to the DISPLAY ERRORS menu option and press the **Enter** button to select.
4. Use the up and down arrows on the **Center** button to view the list of current errors.

Channels Needed

This option displays the number of channels on a DMX link required by the protocol assigned to this fixture (SHOWPIX Standard Protocol requires 70 channels).

Next DMX Channel

Use this option to view the next available DMX Start channel on the link following this fixture and is based on the fixture's specific configuration. The value displayed uses the formula (Current start channel + channels required for the protocol used).

Chapter 4

DMX Programming Basics and Quick Start

If you are new to DMX programming, this chapter will give you a brief overview on programming SHOWPIX® and StudioPix™ fixtures followed by an example using a Wholehog console to patch and display output.

DMX Programming Overview

DMX512 Links

A lighting console typically utilizes a protocol called DMX512 to communicate with automated lighting fixtures and conventional dimmers. This protocol consists of 512 unique channels of control per output link (universe). Typically a lighting fixture or device will use a channel for each parameter's function. Each channel consists of 256 values ranging from 0 to 255. The lighting console is programmed to transmit a corresponding DMX value for the desired function of each parameter. All DMX values are stored within in the lighting console, and typically are referred to as cues, scenes, or presets. A lighting console locates a device on the link by its DMX Start Channel.

8-bit vs. 16-bit DMX Parameters

Most parameters of an automated light use one channel of DMX providing 256 values of control (0-255). This is known as 8-bit DMX. Although most parameters use 8-bit DMX, several require a more accurate range of values than can be provided with a single DMX channel.

By utilizing two DMX channels for a single parameter, 65535 values become available for controlling and adjusting parameter functions. This is known as 16-bit DMX. You can adjust 16-bit DMX values in both coarse and fine increments. The first channel of the pair provides coarse control changes of the DMX value in increments of 256. The second channel provides fine control and changes of the DMX value in increments of 1.

Individual access of the two DMX channels used with 16-bit parameters varies by lighting console. Most modern DMX consoles bind these two channels into a single 16-bit parameter to accurately perform 16-bit crossfades. Consult your lighting console manual for further information.

Determining a DMX Start Channel

The DMX Start Channel is the first channel of a device's channel range on a DMX link. There are 512 available channels on each DMX universe divided among all the devices in a particular universe. A device must have a unique DMX Start Channel number in order to respond independently to controller commands.

To determine each device's DMX Start Channel, identify the footprint of every device on the universe. The device's footprint is the number of consecutive DMX channels a device requires and is determined by the channels in the fixture's protocol. The fixture's DMX channel range must not overlap any other device's channel range on the link. When two devices on the same DMX universe have overlapping channel ranges, one or both devices will be disabled or behave erratically.

Protocol Mode	Description	DMX Channel Range		Last Valid Start Channel	
		SHOWPIX	StudioPix	SHOWPIX	StudioPix
Standard Protocol	Full control of graphic engine with global and two image layers	70	70	442	442
RGB Reduced Protocol	Washlight control only with red, green, blue, intensity, and strobe controls	12	12	501	501
Pixel Mapping Protocol	Individual RGB control of LEDs plus master intensity, and strobe	390	192	123	321
Extended Protocol	Full control of graphic engine with Individual RGB control of LEDs available for additional media input	451	253	62	260

Select the protocol level in the fixture's onboard menu system. The tables on the following pages list the parameters included in each protocol mode.

SHOWPIX and StudioPix Protocol Modes

You can choose from four protocol modes for variable programming styles. High End Systems is currently distributing the detailed DMX protocols as requested to console and visualizer manufacturers in an attempt to ensure that the fixture libraries are created in a method that allows optimum control of the fixture. The charts below provide only an outline of each channel's function. If your console does not provide a library for SHOWPIX and StudioPix fixtures, please contact the console manufacturer to have one created.

Standard Protocol

Standard protocol provides motion control plus full graphics engine control of images, colors, and effects for the two separate image files and the composite image they form. For details on specific DMX parameters, see *Chapters 5–10*.

Standard Protocol Table for SHOWPIX and StudioPix

Motion Control		Global Control		Image Control		
Chan #	Description	Chan #	Description	Image 1 Chan #	Image 2 Chan #	Description
1	Pan	8	Strobe	25	48	Media Folder
2		9	Dim	26	49	Media file
3	Tilt	10	Color Function	27	50	Frame
4		11	Red	28	51	Play mode
5	Mspeed	12		29	52	Play speed
6	Macro	13	Green	30	53	Scale
7	Control Function	14		31	54	Rotate
		15	Blue	32	55	X Position
		16		33	56	Y Position
		17	Scale	34	57	Color Function
		18	Global Rotate	35	58	Red
		19	Dampening	36	59	
		20	Global Transition Mode	37	60	Green
		21	Global Transition	38	61	
		22	Effect Function	39	62	Blue
		23	Effect Modifier 1	40	63	
		24	Effect Modifier 2	41	64	Transparent Color
				42	65	Background Color
				43	66	Image Transition Mode
				44	67	Transition Speed
				45	69	Effect Function
				46	60	Effect Modifier 1
				47	70	Effect Modifier 2

RGB Reduced Protocol

This protocol choice lets you utilize SHOWPIX and StudioPix fixtures as powerful wide angle washlights by providing control of motion and color mixing only.

Note: *Reduced protocol provides 8-bit color control instead of the 16-bit color mixing used in the Standard Protocol*

RGB Reduced Protocol Table for SHOWPIX and StudioPix

Chan #	Description
1	Pan
2	
3	Tilt
4	
5	Mspeed
6	Macro
7	Control Function
8	Strobe
9	Dim
10	Red
11	Green
12	Blue

Pixel Mapping Protocol

Pixel Mapping protocol allows you to individually control RGB color each of the LEDs with your DMX desk or a third party pixel mapping protocol. LEDs are identified by the protocol according to the array maps in the following sections.

SHOWPIX Pixel Mapping Table

A SHOWPIX array consists of 127 LEDs with each acting as a single pixel of an image. The example to the right designates the position of the channels assigned to LEDs in the Pixel Mapping Protocol. The following table shows the color assignment for the LEDs

The following table shows the color assignment for the LEDs. The image below labels each LED position on the array.

Fixture Control		LED Control		
Chan #	Description	Chan #		Description
1	Pan	10	Red	LED 1
2		11	Green	
3		12	Blue	
4	Tilt	...	Red	Adjust three DMX channels for RGB control with values from 0 = no color to 255 = full saturation.
5		...	Green	
6		...	Blue	
7	Control Function	388	Red	LED 127
8	Strobe	389	Green	
9	Dim	390	Blue	

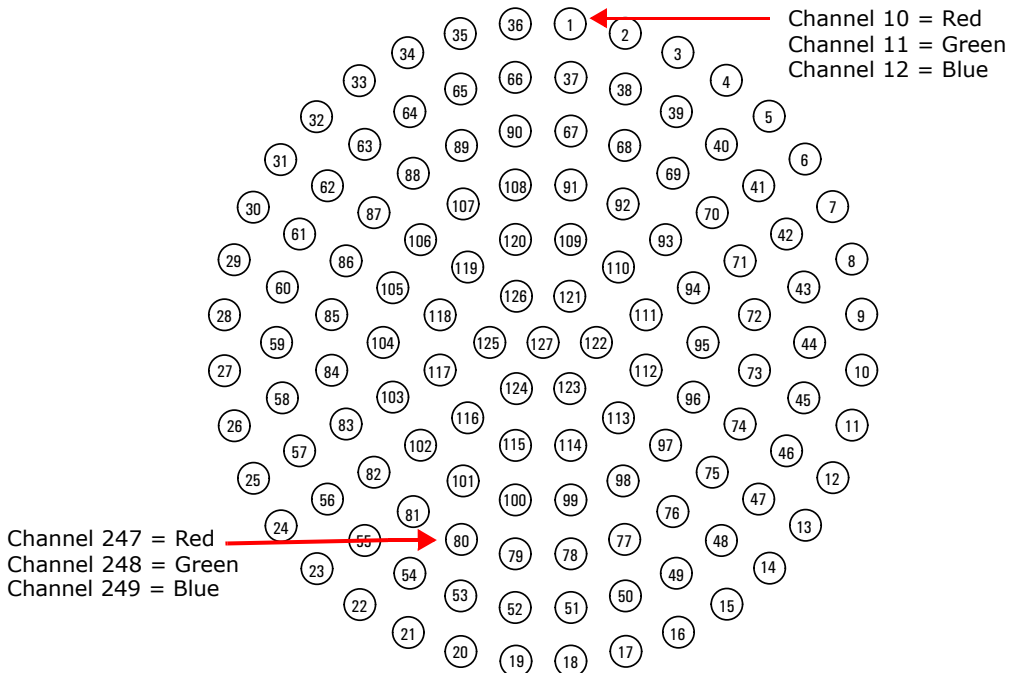

StudioPix Pixel Mapping Table

A StudioPix array consists of 61 LEDs with each acting as a single pixel of an image. The following table shows the color assignment for the LEDs. The image below labels each LED position on the array.

Fixture Control		LED Control		
Chan #	Description	Chan #	Description	
1	Pan	10	Red	
2		11	Green	
3		12	Blue	
4	Tilt	...	Red	Adjust three DMX channels for RGB control with values from 0 = no color to 255 = full saturation.
5	Mspeed	...	Green	
6	Macro	...	Blue	
7	Control Function	190	Red	LED 61
8	Strobe	191	Green	
9	Dim	192	Blue	

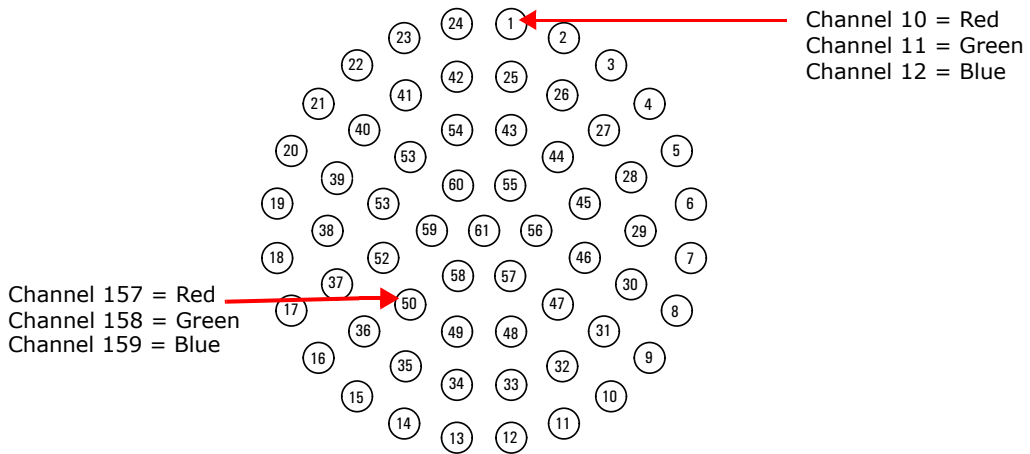

Extended Protocol

Use the Extended Protocol when you want all the movement, global and image control of Standard Protocol plus individual RGB control of individual LEDs. When using Pixel mapping channels in Extended protocol, note the following:

- The Folder channel for a selected image must equal 255 to allow pixel mapping input from on the selected image layer.
- Transparent Color and Background Color will be inactive since they require an image file be selected. Pixel mapping looks only at raw pixel values, not a file.

SHOWPIX and StudioPix Fixtures Extended Protocol Table

Motion Control		Image Control			LED Control	
Chan #	Description	Image 1 Chan #	Image 2 Chan #	Description	Chan #	Description
1	Pan	25	48	Media Folder	71	RGB LED 1
2		26	49	Media file	72	
3	Tilt	27	50	Frame	73	
4		28	51	Play mode	74	
5	Mspeed	29	52	Play speed	75	RGB LED 2
6	Macro	30	53	Scale	76	
7	Control Function	31	54	Rotate	77	RGB LED 3
Global Control		32	55	X Position	78	
Chan #	Description	33	56	Y Position	79	
8	Strobe	34	57	Color Function	80	RGB LED 4
9	Dim	35	58	Red	81	
10	Color Function	36	59		82	
11	Red	37	60	Green	83	RGB LED 5
12		38	61		84	
13	Green	39	62	Blue	85	
14		40	63		86	
15	Blue	41	64	Transparent Color	87	RGB LED 6
16		42	65	Background Color	88	
17	Scale	43	66	Image Transition Mode	89	RGB LED 7
18	Global Rotate	44	67	Transition Speed	90	
19	Dampening	45	69	Effect Function	91	
20	Global Transition Mode	46	60	Effect Modifier 1	...	Note: Continue assigning three channels for RGB control to each LED.
21	Global Transition	47	70	Effect Modifier 2	...	
22	Effect Function				...	
23	Effect Modifier 1				251	
24	Effect Modifier 2				252	LED 61 (last three channels for StudioPix fixture)
					253	
					449	LED 127 (last three channels for SHOWPIX fixture)
					450	
					451	

Lighting Console Tips

Lighting consoles differ in many aspects and it is important to understand how your console operates with SHOWPIX and StudioPix fixtures.

Fixture Libraries:

Many sophisticated lighting consoles utilize pre-made fixture libraries. A fixture library consists of profiles for various types of lighting fixtures and devices. Each profile corresponds to the fixture's DMX protocol and allows for ease of programming. Depending upon the manufacturer of your lighting console, some parameters might have different labels for parameter names and functions than are listed within this manual. Consult your lighting console manual for additional information.

Note: The suggested default DMX values given for each parameter in chapters describing fixture, color, image and global DMX control are recommended to build libraries that provide the easiest and most reliable content selection, and output. They are the default values built into the Wholehog libraries for High End Systems consoles.

Patching SHOWPIX and StudioPix Fixtures Using the Standard Protocol

SHOWPIX and StudioPix fixtures using the Standard protocol are patched as three different "fixture types" in the Wholehog library systems. This allows for ease of programming as well as the ability to adjust quickly for any of the various DMX protocol options. The **Standard** fixture type controls yoke movement and global graphic engine functions such as intensity, color, transitions, etc. The **Image** fixture type controls each image layer functions such as media, color, position, rotation and effects. Because SHOWPIX and StudioPix use two image layers, two **Image** fixture types are needed to control a single fixture.

The best way to organize your patching is to assign user numbers for these items. Patch the Standard fixture type and then the two Image fixtures types. For example, set up user numbers 1-3 that correspond to the fixture number 1, where user number 1 is the Standard, and user numbers 2 and 3 are Image fixture types.

Patching SHOWPIX and StudioPix Fixtures in Other Protocol Modes

For patching Wholehog, use the following:

Reduced Mode

- 1 SHOWPIX or StudioPix Reduced

Pixel Mapping Mode

- 1 SHOWPIX or StudioPix Pixel mapping
- 127 generic RGB LED for SHOWPIX fixtures or 61 generic RGB LED for StudioPix fixtures

Enhanced Mode

- 1 SHOWPIX or StudioPix Standard
- 2 SHOWPIX or StudioPix Image
- 127 generic RGB LED for SHOWPIX fixtures or 61 generic RGB LED for StudioPix fixtures

DMX Output Displays

Although all lighting consoles output the same 512 DMX channels per universe, the on-screen labeling often differs. Parameter functions are displayed in either alpha-numeric descriptions (strobe 1), percentage (0-100%) or decimal (0-255 for 8-bit and 0-65535 for 16-bit). Consult your lighting console manual for further information.

Pixellage Content Playback

To playback Pixellage content, select folder 251 on image layer A or B. When you select a file within this folder, each fixture will play their "section" of the Pixellage image. Each fixture's unique Pixellage section is determined by the Pixellage address assigned prior to the content being uploaded. It is very important to assign the Pixellage addresses to match those within the original Pixellage template. For more information, see the *Echo Software User Manual*.

Wholehog Programming Notes

Play Modes (Intensity)

Using the Image fixture type, press the Mode button to view the play mode options. By default all modes trigger normally. If available per the SHOWPIX or StudioPix DMX protocol, you can select "Media Trigger Intensity" to change to the Play Modes that trigger when Intensity is greater than zero. When using one of these modes, the media will pause when the intensity is at zero and play when the intensity is greater than zero. To restore to normal triggering, select "Media Trigger Normal".

CMY

The Standard and Image fixture types both contain CMY controls for the Color Function modifier channels. For some color function options, the CMY parameters will not adjust color, but will adjust the color function per the SHOWPIX or StudioPix protocol.

The Wholehog libraries default to CMY mode for control of SHOWPIX or StudioPix. This allows for use of standard color mixing, global palettes, and the color and gel pickers.

Custom Wheel Sets

You can import a custom preference file to your Wholehog show file to rearrange the wheelset for easier accessibility to the parameters of SHOWPIX or StudioPix. The wheelset can be found on Wholehog consoles in the Preferences folder or downloaded from:

<http://www.flyingpig.com/support/hog3/downloads/library/index.shtml>.

Quick Start with a Wholehog Console

After Setting up and Configuring the SHOWPIX or StudioPix fixture as outlined in Chapter 2, use the following steps to get to the point of displaying output.

Step 1: In the *Fixture Schedule* window of Wholehog software, Add one Standard and two Image “fixtures” for each unit.

Step 2: Assign user numbers for these items. Set up user numbers 1-3 that correspond to SHOWPIX or StudioPix unit number 1, where user number 1 is the Standard, 2 and 3 are Image fixture types. Patch the Standard first and then the two Image fixture types.

Chapter 5

Fixture Control

This chapter describes mechanical movement control for SHOWPIX™ and StudioPix™ fixtures in all protocol modes.

Pan and Tilt

SHOWPIX fixtures have a 400° pan range and a 240° tilt range. StudioPix fixtures have a 540° pan range and a 210° tilt range.

Two DMX channels for **Pan** and two for **Tilt** provide 16-bit position adjustment to a fraction of a degree.

MSpeed values can control the timing of pan and tilt motion for SHOWPIX and StudioPix fixtures. To control Pan and Tilt movement timing via a DMX controller crossfading, leave the Pan/Tilt MSpeed in its default Off setting.

Note: SHOWPIX and StudioPix fixtures use optical encoders for pan and tilt to instantly correct the fixture's position if the fixture is jarred from its programmed position.

If a physical obstruction prevents the fixture from correcting its position, this correction feature "times out" to prevent wear on the motors.

If the fixture's position correction has timed out, remove the obstruction and home the fixture to return it to normal operation.

MSpeed (Motor Speed)

The **MSpeed** parameter adjusts the time required for a motor to complete movement when changing from one position to another. MSpeed provides a method for all motors to reach their target position at the same time, even though each motor may have different distances to travel. MSpeed movement is extremely smooth because the fixture controls movements independent of DMX refresh rates.

MSpeed times vary from 0.15 seconds to 252.7 seconds. In general, allowing the console to crossfade the pan and tilt values for a SHOWPIX fixture is acceptable. However, extremely slow movements may require the use of MSpeed instead of console crossfades. For a listing of exact MSpeed times, see *Appendix A: MSpeed Conversion Table* on page 75.

Macros

The Macro parameter controls Internal Effects™ macros. These are factory-programmed sequences that allow you to quickly program complicated looks in one scene (cue). Each Internal Effect™ macro modifies a specific set of parameters, while allowing user control of all other parameters in the scene. The amplitude of the position macro movement is determined by the Pan Coarse channel and Tilt Coarse channel, respectively. The MSpeed channel controls the speed of the macros. You can choose from the following Macros:

- Pan sweep, small to large angle
- Tile Sweep, small to large angle
- Clockwise circle, small to large
- Counterclockwise circle, small to large

With the MSpeed set at the default value of DMX 0-4, an Internal Effects macro completes its movement in approximately 2.5 seconds. This provides a pleasing look when the additional variation given by using the MSpeed channel is not required. With the MSpeed set between DMX 5-255, Internal Effects macros complete movement at the selected MSpeed time (up to 25 seconds).

Control Function Options

The **Control** parameter remotely initiates various fixture operations.

Note: *All of the following Control parameter settings (except for the Safe and Outrig mode options), require that the Dim channel value equals zero.*

DMX Value (dec.)	Control Option	Description
0-9	Safe	Disables all Control setting
20-28	Display Off	Turns the Display off
40-48	Display Bright	Sets the Display to bright
60-68	Home	Remotely homes all the motion functions of the fixture
120-130	Shutdown	Remotely deactivates the fixture. When a fixture is shut down, the graphic engine stops, power to the motors is disabled, and the menu display reads SHUT DOWN in SHOWPIX fixtures or S/DN in StudioPix fixtures. If a fixture is in shutdown mode, you must home the fixture to bring it back into operation.
131-140	Outrig Mode	This option applies to SHOWPIX fixtures only. For more information, see <i>Chapter 2: Setup and Configuration</i> in the SHOWPIX User Manual. It insures uninterrupted movement of pan and tilt for fixtures side mounted or in acute angular positions. Because this is a DMX mode, it will not persist in the fixture.

Chapter 6

Color Control

The Standard protocol modes for SHOWPIX and StudioPix fixtures provide color mixing control for up to two image files and a composite image. Other protocol modes provide washlight operation or individual LED color mixing.

The type of color control depends on the protocol mode you select for the fixture:

- **Standard** protocol assigns two channels each for Red, Green, and Blue parameters to provide 16-bit color mixing for each of the two images and the global composite image. Several color mixing modes are available (see *Color Function Parameter* on page 44).
- **Reduced** protocol assigns three channels for 8-bit Red, Green, and Blue color mixing.
- **Pixel Mapping** protocol gives you precision color control of every “pixel” of the fixture array with 8-bit color mixing for each LED.
- **Extended** protocol provides all the color control offered in Standard protocol plus individual LED color mixing.

For a table of each protocol mode’s parameters, see *SHOWPIX and StudioPix Protocol Modes* on page 33.

Color Parameters

Red, Green and **Blue** parameters let you control color mixing and in Standard and Extended protocol, provide adjustment for various Color function options.

Default DMX Value = 0: No color (All protocol types)

In Standard and Extended protocol **Red, Green,** and **Blue** parameters adjust from no color at a DMX value = 0 to full saturation at a DMX value = 65,535.

Note: *To Control LEDs as a Single Color in Standard or Extended protocol modes, set Folder and File and Color Function parameters to a DMX value = 0. The output will display a solid color you can adjust with the Red, Green and Blue parameters.*

In Reduced protocol, the **Red, Green,** and **Blue** parameters adjust a single color value for all LED’s from no color at a DMX value = 0 to full saturation at a DMX value = 255.

Pixel Mapping protocol assigns a Red, Green and Blue parameter to each of the LEDs to adjust the Red, Green, and Blue component of the output for that LED. Values range from no color at a DMX value = 0 to full saturation at a DMX value = 255.

Color Function Parameter

In Standard and Extended protocol, the **Color Function** parameter is available at both the image level and the global level. This gives you the ability to apply a color effect to one or both image layers and also to the composite image.

NOTE: *Choosing a Color Function may change the functionality of the Red, Green and Blue channels.*

Color Function Parameter		Adjustments		
DMX Value	Option Description	Red Parameter	Green Parameter	Blue Parameter
0	RGB Add. Standard RGB add to all Pixels	Red	Green	Blue
1	CMY. Simulates CMY by subtracting RGB	Cyan	Magenta	Yellow
2	Black and White.			
3	Black and White Inverted.			
4	RGB Add non-black pixels.	Red	Green	Blue
5	RGB Swap to GBR. redefines component color	Red to Green	Green to Blue	Blue to Red
6	RGB Swap to BRG. redefines component color	Red to Blue	Green to Red	Blue to Green
7	RGB Swap to BGR. redefines component color	Red to Blue	Green	Blue to Red
8	RGB Swap to RBG. redefines component color	Red	Green to Blue	Blue to Green
9	RGB Swap to GRB. redefines component color	Red to Green	Green to Red	Blue
10	RGB Invert. converts red to inverted red, green to inverted green, blue to inverted blue	Red to Cyan	Green to Magenta	Blue to Yellow
11	RGB Invert & Swap to GBR. converts red to inverted green, green to inverted blue, blue to inverted red	Red to Magenta	Green to Yellow	Blue to Cyan
12	RGB Invert & Swap to BRG. Red to inverted blue, green to inverted red, blue to inverted green	Red to Yellow	Green to Cyan	Blue to Magenta
13	Solarize 1 If color value < threshold value, invert color	Red	Green	Blue
14	Solarize 2 If color value > threshold, invert color.	Red	Green	Blue
15	Solarize 3 If color value < threshold, set color to 0	Red	Green	Blue
16	Solarize 4 If color value > threshold, set color to 0	Red	Green	Blue
17	Color Cycle DMX value controls cycle speed.	Red	Green	Blue
18	Random Color	Sets Rate	Not Used	Not Used
19	Scale multiplies the color values	Red	Green	Blue
20	Compress to Maximum reduces the color value range from minimum to 65,635	Sets Red Minimum	Sets Green Minimum	Sets Blue Minimum
21	Add color to black adds RGB to black pixels	Red	Green	Blue
22	Replace Background Color	Red	Green	Blue
23	Rainbow Color Cycle	Controls cycle speed	Controls color offset	Not Used

The following section provides a more detailed description of Color Function parameter options in alphabetical order.

Color Function Descriptions

Add Color to Black

This option adds color to black pixels only.

Color Function parameter DMX value = 21

Red Parameter: Increases the red color component from 0 = no adjustment to 65,535 (100%) = maximum red saturation.

Green Parameter: Increases the green color component from 0 = no adjustment to 65,535 (100%) = maximum green saturation.

Blue Parameter: Increases the blue color component from 0 = no adjustment to 65,535 (100%) = maximum blue saturation.

Black and White

Use this option to convert color image to black and white.

Color Function parameter DMX value = 2

Red, Green and Blue modifier parameters are not used.

Black and White Inverted

This option removes all color and then swaps the black and white pixels.

Color Function parameter DMX value = 3

Red, Green and Blue modifier parameters are not used.

CMY

Color Function parameter DMX value = 1

This option simulates CMY color by inverting RGB color components and is the default value for the color function parameter. Use this parameter when you want to color mix with a CMY color model instead of RGB.

Red Parameter: Increases cyan color component from 0 = no adjustment to 65,535 (100%) = maximum cyan saturation.

Green Parameter: Increases magenta color component from 0 = no adjustment to 65,535 (100%) = maximum magenta saturation.

Blue Parameter: Increases yellow color component from 0 = no adjustment to 65,535 (100%) = maximum yellow saturation.

Color Cycle

Color Function parameter DMX value = 17

The image's color components cycle through RGB, black, and white. When no Red Green or Blue is added, image fades from full white, to normal image, to black. When RGB/CMY is added the image fades from the RGB value, to the image with color added. Individual color components are modulated individually, the speed of the modulation for a particular component is based on the red, green or blue DMX values respectively.

Red Parameter: Controls the cycle speed from 0 slow to maximum speed at a DMX value = 255 (100%).

Green Parameter: Controls the offset of the color cycle. At a DMX value = 128 (50%) there is no adjustment. Values below the midpoint cycle through the palette in reverse at an increasing speed to a maximum offset at a DMX value = 0. Values above the midpoint cycle forward through the palette at an increasing speed to maximum offset at a DMX value = 255 (100%).

Blue Parameter: Not Used

Compress to Maximum

Color values are compressed toward the high end of the color range.

Color Function parameter DMX value = 20

Red Parameter: Adjusts the compression for the red color component from 0 = no adjustment to 65,535 (100%) = maximum red saturation.

Green Parameter: Adjusts the compression for the green color component from 0 = no adjustment to 65,535 (100%) = maximum green saturation.

Blue Parameter: Adjusts the compression for the blue color component from 0 = no adjustment to 65,535 (100%) = maximum blue saturation.

Rainbow Color Cycle

Color Function parameter DMX value = 23

Maps the colors in the media to a table creating a multi color pattern that moves across the image. This effect cycles through a rainbow color palette, adding palette values to pixel.

Red Parameter: Controls the cycle speed from 0 slow to maximum speed at a DMX value = 255 (100%).

Green Parameter: Controls the offset to vary the patterns color mapping. At a DMX value = 128 (50%) there is no adjustment. Values below the midpoint cycle through the palette in reverse at an increasing speed to a maximum offset at a DMX value = 0. Values above the midpoint cycle forward through the palette at an increasing speed to maximum offset at a DMX value = 255 (100%).

Blue Parameter: Not Used

Random Color

Color Function parameter DMX value = 18

Red Parameter: Controls the cycle speed from 0 = slow to maximum speed at a DMX value = 255 (100%).

Green Parameter: Not used

Blue Parameter: Not Used

Replace Background Color

Color Function parameter DMX value = 22

Selects the background color to be viewed through transparent components of the image.

Red Parameter: Increases the red color component from 0 = no adjustment to 65,535 (100%) = maximum red saturation.

Green Parameter: Increases green color component from 0 = no adjustment to 65,535 (100%) = maximum green saturation.

Blue Parameter: Increases blue color component from 0 = no adjustment to 65,535 (100%) = maximum blue saturation.

RGB Add non-black pixels

Color Function parameter DMX value = 4

This option adds color to all pixels except black using the RGB color model.

Red Parameter: Increases the red color component from 0 = no adjustment to 65,535 (100%) = maximum red saturation.

Green Parameter: Increases green color component from 0 = no adjustment to 65,535 (100%) = maximum green saturation.

Blue Parameter: Increases blue color component from 0 = no adjustment to 65,535 (100%) = maximum blue saturation.

RGB Add, All Pixels

Color Function parameter DMX value = 0

This option adds color to all pixels including black using the RGB color model.

Red Parameter: Increases the red color component from 0 = no adjustment to 65,535 (100%) = maximum red saturation.

Green Parameter: Increases green color component from 0 = no adjustment to 65,535 (100%) = maximum green saturation.

Blue Parameter: Increases blue color component from 0 = no adjustment to 65,535 (100%) = maximum blue saturation.

RGB Invert & Swap to BRG

Color Function parameter DMX value = 12

This option swaps the color values from RGB to an inverted BRG color model.

Red Parameter: Transitions the red component from no adjustment at a value of 0 to yellow at a value of 65,535 (100%)

Green Parameter: Transitions the green component from no adjustment at a value of 0 to cyan at a value of 65,535 (100%)

Blue Parameter: Transitions the blue component from no adjustment at a value of 0 to magenta at a value of 65,535 (100%)

RGB Invert & Swap to GBR

Color Function parameter DMX value = 11

This option swaps the color values from RGB to an inverted GBR color model.

Red Parameter: Transitions the red component from no adjustment at a value of 0 to magenta at a value of 65,535 (100%)

Green Parameter: Transitions the green component from no adjustment at a value of 0 to yellow at a value of 65,535 (100%)

Blue Parameter: Transitions the blue component from no adjustment at a value of 0 to cyan at a value of 65,535 (100%)

RGB Invert

Color Function parameter DMX value = 10

This option inverts color values to transition the image from an RGB to a CMY color model.

Red Parameter: Transitions the red component from no adjustment at a value of 0 to cyan at a value of 65,535 (100%)

Green Parameter: Transitions the green component from no adjustment at a value of 0 to magenta at a value of 65,535 (100%)

Blue Parameter: Transitions the blue component from no adjustment at a value of 0 to yellow at a value of 65,535 (100%)

RGB Swap to BGR

Color Function parameter DMX value = 7

This option allows you to swap colors. All red values become green and all blue values become red. Green values are unaffected.

Red Parameter: Transitions red color component to blue from 0 = no color change to 65,535 (100%) = green

Green Parameter: No change to green color component

Blue Parameter: Transitions blue color component to green from 0 = no color change to 65,535 (100%) = red

RGB Swap to BRG

Color Function parameter DMX value = 6

This option allows you to swap colors. All red values become blue, all green values become red and all blue values become green.

Red Parameter: Transitions red color component to blue from 0 = no color change to 65,535 (100%) = blue

Green Parameter: Transitions green color component to red from 0 = no color change to 65,535 (100%) = red

Blue Parameter: Transitions blue color component to green from 0 = no color change to 65,535 (100%) = green

RGB Swap to GBR

Color Function parameter DMX value = 5

This option allows you to swap colors. All red values become green, all green values become blue and all blue values become red.

Red Parameter: Transitions red color component to green from 0 = no color change to 65,535 (100%) = green

Green Parameter: Transitions green color component to blue from 0 = no color change to 65,535 (100%) = blue

Blue Parameter: Transitions blue color component to red from 0 = no color change to 65,535 (100%) = red

RGB Swap to GRB

Color Function parameter DMX value = 9

This option allows you to swap colors. All red values become green and all green values become blue. Blue values are unaffected.

Red Parameter: Transitions red color component to green from 0 = no color change to 65,535 (100%) = green

Green Parameter: Transitions green color component to red from 0 = no color change to 255 (100%) = blue

Blue Parameter: No change to blue color component

RGB Swap to RBG

Color Function parameter DMX value = 8

This option allows you to swap colors. All green values become blue and all blue values become green. Red values are unaffected.

Red Parameter: No change to red color component

Green Parameter: Transitions green color component to blue from 0 = no color change to 65,535 (100%) = blue

Blue Parameter: Transitions blue color component to green from 0 = no color change to 65,535 (100%) = red

Scale

Compresses the color values to intensify the color

Color Function parameter DMX value = 19

Red Parameter: Adjusts the compression for the red color component from 0 = no adjustment to 65,535 (100%) = maximum red saturation.

Green Parameter: Adjusts the compression for the green color component from 0 = no adjustment to 65,535 (100%) = maximum green saturation.

Blue Parameter: Adjusts the compression for the blue color component from 0 = no adjustment to 65,535 (100%) = maximum blue saturation.

Solarize

Solarize 1

Color Function parameter DMX value = 13

Solarize 2

Color Function parameter DMX value = 14

Solarize 3

Color Function parameter DMX value = 15

Solarize 4

Color Function parameter DMX value = 16

Each of the Solarize options remaps colors to a narrow value range and inverts the color below a set threshold using different algorithms. Solarize options can create strong highlights.

Red Parameter: Increases red color component from 0 = no adjustment to 65,535 (100%) = maximum red saturation. Red color values below the threshold are converted to cyan.

Green Parameter: Increases blue color component from 0 = no adjustment to 65,535 (100%) = maximum blue saturation. Blue color values below the threshold are converted to magenta.

Blue Parameter: Increases green color component from 0 = no adjustment to 65,535 (100%) = maximum green saturation. Green color values below the threshold are converted to yellow.

Transparent Color

Default DMX Value = 0: Use pre-defined image transparency

The Transparent parameter lets you set a color value from the file as transparent. When you designate a transparency on an Image layer, a layer placed “behind” it will show through the transparent pixels. You can also designate a background color to show through.

The ability to “see” one layer behind another when using transparent color is determined by the current selection in the global Transition Mode parameter. Global Transition Mode determines the relationship of the Image layers to each other and, depending on the type of transition, what will be seen through the transparency of the selected Image layer, (see *Transitions and Color Transparency* on page 63).

Set the Transparent parameter DMX value = 0 for custom files that have a transparent component predefined. A DMX value = 1 sets the black pixels as transparent and a DMX value = 2 makes white components of the image transparent.

You can select any of the LED colors assigned to the image as transparent with DMX values from 3-254. Use the Echo application to view the palette of LED color assignments for a media file (Refer to the Echo Software User Manual available on the SHOWPIX support page at highend.com/support).

Background Color

Default DMX Value = 0: no Image Layer background color

You may have a situation when applying certain layer effects, when only a portion of the LED array is covered by the image. For example you may scale down the image or move it's position in the x or y direction. In this case you will see any image defined in a layer behind it or if that layer is transparent or not defined, any global background color you have selected.

The **Background Color** parameter allows you to set a color for all of the LEDs that are off in the image layer. This background color will block the view of a second layer or a global background color effect. You can select one of the 256 available colors by choosing a DMX value from 1-255. The illustration and table below show the color palette and DMX values for some sample colors.

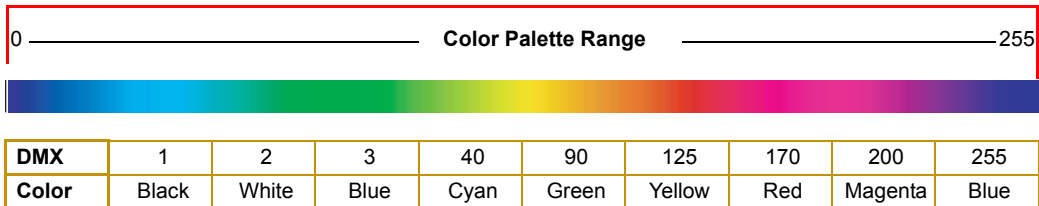

Chapter 7

Global Control

Global controls affect the composite image created when you define two Image layers.

You can use global parameters to adjust intensity, scale and rotation the composite image. Other parameters apply strobing, dampening and a variety of graphic effects. The ability to control dynamic transitions between layers also provides additional looks and effects, (see *Chapter 8: Global Control: Transitions* on page 57. For global color mixing and color effects available, see *Chapter 6: Color Control* on page 43.

Dim

The **Dim** parameter adjusts the overall LED output from off at a DMX value of 0 to full intensity at a value of 255 (100%).

Default DMX Value: 0 = LEDs off

Tip: The Dim parameter needs a DMX value greater than 0 for a defined image to be visible.

Strobe

The Strobe parameter affects the combined output of both image settings. You can choose from the following strobing options:

Strobe Option	Description
Periodic strobe	Strobes the output at specified intervals from slow to fast.
Random strobe	Strobes the output at random intervals from slow to fast.
Random/Synchronous Strobe	Strobes the output at random intervals in unison from slow to fast.

Note: *An option in each image layer's effect parameter allows the user to strobe a layer individually, (see Effect Function on page 73).*

Scale

You can magnify or reduce the composite image size using the Scale Parameter.

Default DMX Value: 128 (50%) = Normal Scale

The Scale parameter adjusts the size of the composite image up to approximately 10x its original size. At a DMX value of zero, the image shrinks to the minimum size. At the midpoint of the DMX value range, the image is normal size. When the DMX value is increased from the midpoint, the image is enlarged to the maximum at a value of 255 (100%).

Note: *Each image layer has a Scale parameter that lets you scale a layer individually. See Scale Parameter on page 70 for a graphic that illustrates the Scale effect.*

Rotate

The global **Rotation** parameter controls the composite image rotation up to 360° around the Z axis. This parameter does not override rotation setting for the individual image layers but adds to it.

Default DMX Value: 0 = no rotation

DMX values between 0 and 128 (50%) control indexed rotation from 0° - 360°. At 128 (50%), rotation stops. When the DMX value is greater than the 128 (50%), the image begins rotating continuously. DMX values from 128 (50%) to 191 (75%) decrease the speed of continuous clockwise rotation. A DMX value = 191 stops rotation and values from 191 (75%) to 255 (100%) increase continuous rotation speed in a counterclockwise direction.

Tip : If you want to index the rotation counterclockwise, set the starting DMX value = 128 (50%) and move toward zero.

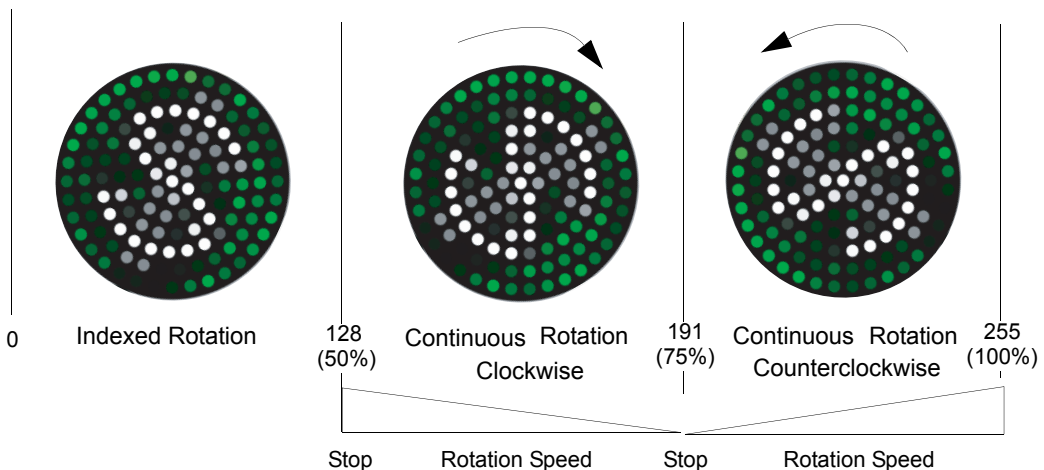

Dampening

Dampening smooths DMX crossfades of X and Y image position changes as well as indexed rotation changes. When a long DMX crossfade occurs on these parameters, use the Dampening channel to smooth the resolution of the image position change.

Default DMX Value: 0 = Disable Dampening

You can increase the Dampening effect from a minimum at a DMX value of 1 to the maximum effect at a DMX value of 255 (100%).

Global Transition

The **Transition Mode** and **Transition** parameters create real time crossfades, wipes, and transitions from one layer to another. For information on these parameters, see *Chapter 8: Global Control: Transitions* on page 57.

Global Effects

There are several Effect Function options you can apply to the composite image you create by defining Image A and Image B. The type of adjustment made by two Modifier parameters depend on the option you select.

DMX Value	Name	Description	Adjustments	
			Modifier 1	Modifier 2
0	None	No effects selected	NA	NA
1	Background Color	Specifies a color to be view through a transparent portion of a file.	Selects Color	Sets Color Intensity
2	Pan and Tilt Sync	Synchronizes image movement with Pan and Tilt movement	Horizontal	Vertical
3	Shake	Shakes the current visible image along the x and/or y axes	Horizontal	Vertical
4	Bar Scan	Blacks out a portion of the image and creates a visible "bar" that scans across the LED array	Selects Pattern line	Scan Rate
5	Target Scan	Blacks out a portion of the image in a "target" pattern across the LED array.	Selects Pattern Ring	Scan Rate
6	Curtain Scan	Blacks out a portion of the image and creates a "curtain" pattern (two parallel bars) that open across the LED array.	Selects Pattern line position	Scan Rate
7	Mirror	Mirrors the visible image on the X and/or Y axis.	Horizontal	Vertical
8	Brightness and Contrast	Adjusts the brightness and/or contrast of the visible image.	Brightness	Contrast
9	Filters	Enables the rainbow color effect to flow through the image in a predetermined order of the LEDs	Selects Filter	Filter Cycle Rate
10	Flip	Flips the visible image on the X and/or Y axis	Horizontal	Vertical

Chapter 8

Global Control: Transitions

The Transition Mode and Transition parameters provide over 70 patterns for switching between image layers and interact with the Color Transparency parameter to create a wide range of looks.

SHOWPIX and StudioPix fixtures operate in a similar manner to media server based digital lights such as DL.3 and Axon, but inherently it has a very unique graphic's engine. The graphics engine in SHOWPIX and StudioPix is based on a "Composite Mixer" concept for control of the two image layers. The composite mixer uses the **Transition Mode** and **Transition** parameters to create real time crossfades, wipes, and transitions from one layer to another.

Transition Types

To understand how transitions function, think of the two images as separate layers that move together to mix colors and then replace each other. Depending on the transition, the relationship between the layers will operate differently.

Note: *The type of transition assigned will also determine how the Color Transparency will be interpreted, (see Transitions and Color Transparency on page 63).*

There are three basic types of transition options:

- **Opacity** transitions vary the intensity of Image A and Image B.
- **Reveal** transitions open a pattern in one Image layer that reveals the other.
- **Overlay** transitions cover, uncover or push one Image layer with the other.

Two special case Transition Mode options are also available:

- The **Random Transition** option cycles through all the transition options except for itself and the Snap option.
- The **Snap** option switches from one Image layer to the other at a DMX value of 127 (50%) (both Image files are at full intensity).

Opacity Transitions

Normal Fade

Transition Mode DMX value = 0

A normal fade transition option is the default at a DMX value of 0. In this case, Image layers A and B are arranged on the same plane and the intensity of each is varied to create a fade effect.

When the global Transition channel has a DMX value = 0, Image A is visible at full intensity. When the Transition channel is at a DMX value = 255 (100%), only Image B is visible. As the DMX value of the Transition channel is increased from 0% to 100%, the layer intensities change and color mix from Image A to Image B in a smooth fade.

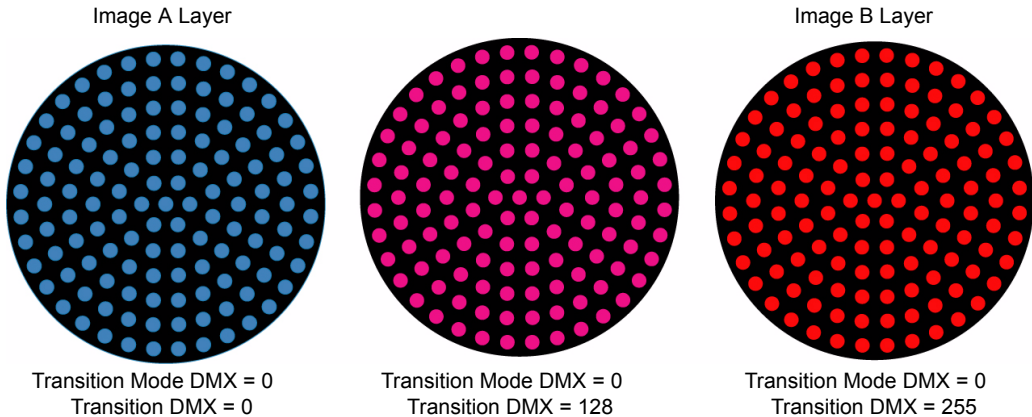

Fade Through Black

Transition Mode DMX value = 69

Fade Through Black is another opacity transition. In this case, the intensity of Image A decreases to black and then Image B intensity increases from black to full. When the global Transition channel has a DMX value = 0 -127% only Image A is visible. At DMX values from 128 - 255 (100%), only Image B is visible.

Image A intensity decreases from full at a DMX value of 0% to a minimum intensity at a DMX value of 126 (49%). The image will be solid black at a DMX value of 127 (50%). Values above the midpoint increase Image B intensity from minimum at a DMX value of 128 to full intensity at a DMX value of 255 (100%).

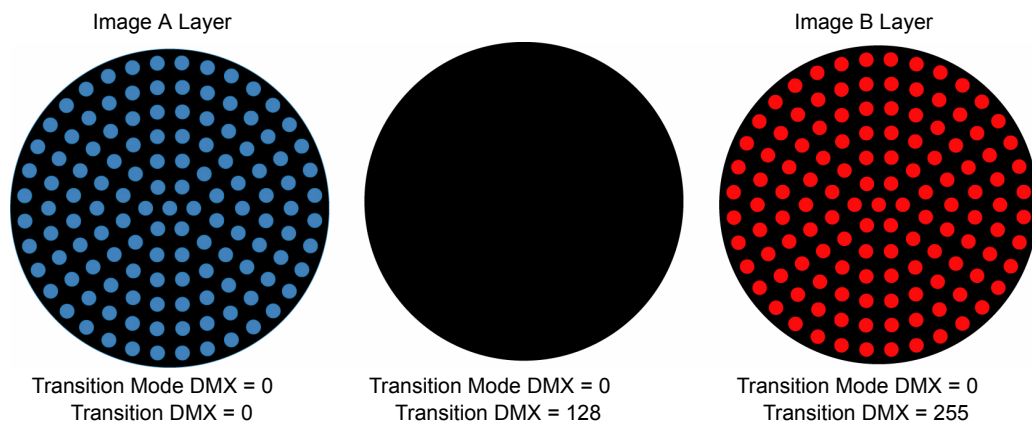

Reveal Transitions

In the second type of transition, one Image is revealed through another in a specified pattern. Both image layers maintain 100% intensity. You can choose from multiple patterns you can specify from the center out or the perimeter into the display. Other reveal transitions reveal in a horizontal, vertical or corner progression.

In the following example, Image A is defined as a solid blue and Image B as a solid red. A DMX value of 5 is set in the Transition Mode parameter (Plus Out). As you increase the DMX value in the Transition parameter, a plus pattern opens from the center of Image A revealing Image B. The pattern continues to expand the area revealed until, at 100%, only Image B is visible.

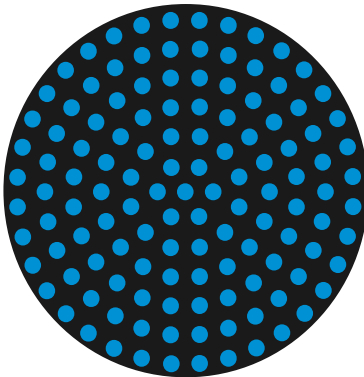

Transition Mode DMX = 6
Transition = 0

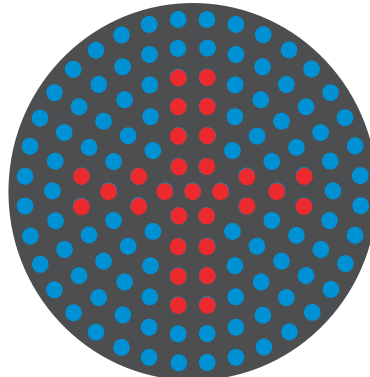

Transition Mode DMX = 6
Transition = 128 (50%)

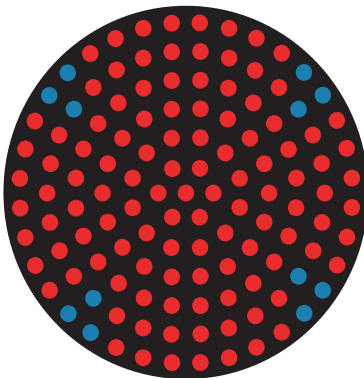

Transition Mode DMX = 6
Transition = 192 (75%)

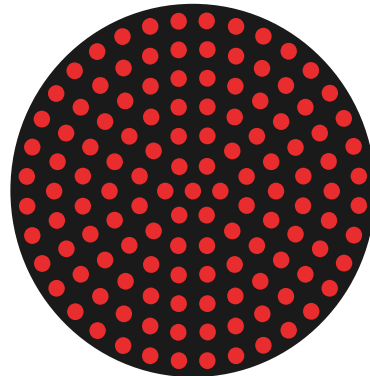

Transition Mode DMX = 6
Transition = 255 (100%)

Tip: Reveal transitions work best when using Transparent colors because one layer will be in front of the other.

Overlay Transitions

In this type of transition, one Image layer covers or moves the other from a position “outside” in a defined pattern. One Image can move to cover or uncover the other. Push options simulate one image moving the other image “off the display”.

Note: *With Push options, pixels will be off when neither Image is represented in that area of the display.*

In this type of transition, both Image Layers maintain their full intensity level.

In the following example Image A is defined as solid red and Image B as solid yellow with an overlay transition option *Cover from Top* selected.

The effect simulates Image B moving over to cover Image A from above.

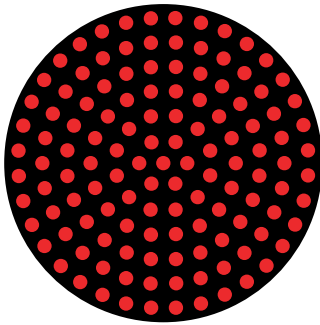

Transition Mode DMX = 46
Transition = 0

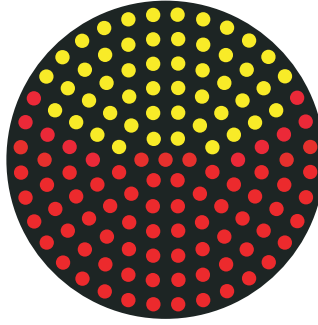

Transition Mode DMX = 46
Transition = 127 (50%)

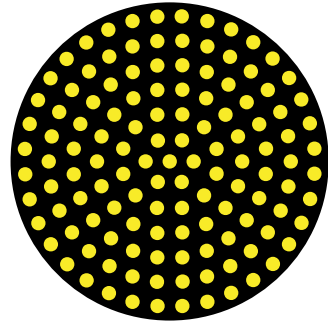

Transition Mode DMX = 46
Transition = 255 (100%)

Transition Mode Parameter

Transition Mode Default DMX Value: 0 = Normal Fade

The following table outlines the different transition patterns and their transition type

DMX Value	Transition Pattern	Description	Transition Type
0	Normal Fade	Image intensities are varied to simulate a smooth crossfade from one to the other.	Opacity
1	Circle In	A circular pattern opens <i>Out</i> from the center or <i>In</i> from the edge in the first Image layer to reveal the second Image layer.	Reveal
2	Circle Out		
3	Spiral In	A spiral pattern opens <i>Out</i> from the center or <i>In</i> from the edge in the first Image layer to reveal the second Image layer.	Reveal
4	Spiral Out		
5	Plus In	A plus sign pattern opens <i>Out</i> from the center or <i>In</i> from the edge in the first Image layer to reveal the second Image layer.	Reveal
6	Plus Out		

DMX Value	Transition Pattern	Description	Transition Type
7	Diamond In	A diamond pattern opens <i>Out</i> from the center or <i>In</i> from the edge in the first Image layer to reveal the second Image layer.	Reveal
8	Diamond Out		
9	Box In	A box pattern opens <i>Out</i> from the center or <i>In</i> from the edge in the first Image layer to reveal the second Image layer.	Reveal
10	Box Out		
11	Split Horizontal In	Splits the screen horizontally and opens <i>Out</i> from the center or <i>In</i> from the edge in the first Image layer to reveal the second Image layer.	Reveal
12	Split Horizontal Out		
13	Split Vertical In	Splits the screen vertically and opens <i>Out</i> from the center or <i>In</i> from the edge in the first Image layer to reveal the second Image layer.	Reveal
14	Split Vertical Out		
15	Blinds Horizontal	Simulates <i>Horizontal</i> or <i>Vertical</i> venetian blinds opening in the first Image to reveal the second Image.	Reveal
16	Blinds Vertical		
17	Checkerboard Horizontal	A checkerboard pattern opens <i>horizontally</i> or <i>vertically</i> in the first Image layer to reveal the second Image layer.	Reveal
18	Checkerboard Vertical		
19	Comb Horizontal	A pattern simulating the teeth of a comb moving together <i>Horizontally</i> or <i>Vertically</i> in the first Image to reveal the second Image.	Reveal
20	Comb Vertical		
21	Random Bars Horizontal	A random bar pattern moving <i>Horizontally</i> or <i>Vertically</i> in the first Image to reveal the second Image.	Reveal
22	Random Bars Vertical		
23	Strips Left Up	A diagonal stripe pattern opens in the first image layer from different positions to reveal the second image layer.	Reveal
24	Strips Right Up		
25	Strips Left Down		
26	Strips Right Down		
27	Wedge from Left	A wedge of the circular array opens toward the center in different directions to reveal the second layer	Reveal
28	Wedge from Right		
29	Wedge from Up		
30	Wedge from Down		
31-38	Wheel 1 spoke, clockwise rotation	A wheel with different spoke and rotation options opens on the first image layer to reveal the second image layer.	Reveal
32	Wheel 2 spokes, clockwise rotation		
33	Wheel 3 spokes, clockwise rotation		
34	Wheel 6 spokes, clockwise rotation		
35	Wheel 1 spoke, counterclockwise rotation		
36	Wheel 2 spokes, counterclockwise rotation		
37	Wheel 3 spokes, counterclockwise rotation		
38	Wheel 6 spokes, counterclockwise rotation		

DMX Value	Transition Pattern	Description	Transition Type
39	Spider Spiral In	A spiral pattern variation opens <i>Out</i> from the center or <i>In</i> from the edge in the first Image layer to reveal the second Image layer.	Reveal
40	Wipe Left	Wipes across the first image layer to reveal the second image layer.	Reveal
41	Wipe Right		
42	Wipe Up		
43	Wipe Down		
44	Cover from Left	The first image layer “moves over” the second image layer from multiple directions.	Overlay
45	Cover from Right		
46	Cover from Top		
47	Cover from Bottom		
48	Cover from Top Left		
49	Cover from Top Right		
50	Cover from Bottom Left		
51	Cover from Bottom Right	The first image layer “moves off” the second image layer in the selected direction	Overlay
52	Uncover from Left		
53	Uncover from Right		
54	Uncover from Top		
55	Uncover from Bottom		
56	Uncover from Top Left		
57	Uncover from Top Right	The first image layer pushes the second image layer out of the frame from the selected direction	Overlay
58	Uncover from Bottom Left		
59	Uncover from Bottom Right		
60	Push from Left		
61	Push from Right		
62	Push from Top		
63	Push from Bottom		
64	Push from Top Left		
65	Push from Top Right	A random dot pattern drops out of Image A to reveal Image B	Reveal
66	Push from Bottom Left		
67	Push from Bottom Right	Image A intensity from full to black for half the range and Image B from full to black for half the range.	Opacity
68	Random Dissolve		
69	Fade Through Black	Cycles through all the transition options except the Snap option.	NA
70	Random Transition		
71	Snap	Switches from one Image layer to the other at a DMX value of 127 (50%) (both Image files are at full intensity)	NA
72	Gothic Discus	Opens a pattern in the first image layer to reveal the second.	Reveal
73	Gothic Discus2	Opens a pattern in the first image layer to reveal the second.	Reveal

Transition Parameter

Transition Default DMX Value: 0 = Image A layer is fully visible

After you select a pattern option in the Transition Mode parameter, the Transition parameter defines the transition between Image A and Image B.

For DMX values = 0 to 126 (49), Image A is “in front” of Image B and fully visible. At a DMX value = 128 (50%), Image A and Image B are both fully visible. DMX values above 50% place Image B in front.

Transitions and Color Transparency

Knowing the type of transition mode you have selected will help you interpret the color transparency effect. The following examples show the relationship between the transparency function and the transition type.

Transparency with Opacity Transitions

Opacity Transitions place the two image layers on the same plane. Transparent colors on either Image Layer will only reveal the background color (if applied).

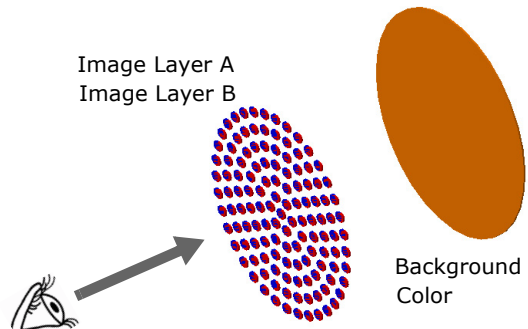

Transparency with Reveal Transitions

Reveal Transitions simulate the placement one layer in front of the other. Colors in an image defined as transparent on the front image layer will reveal the other image layer. When the transition channel is a DMX 0 Image Layer A is in front of layer B. At DMX 255 Image Layer B is in front of layer A.

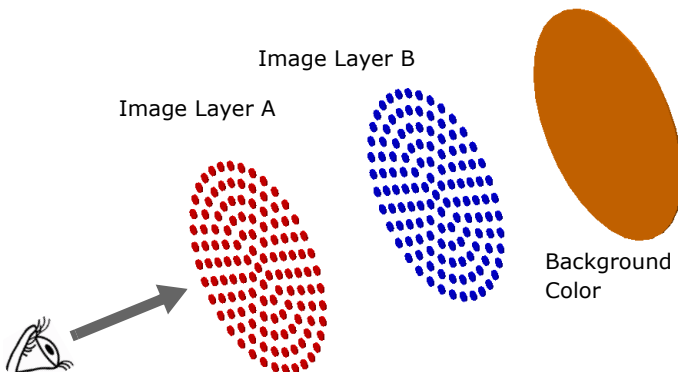

Transparency with Overlay Transition

Overlay Transitions place one layer beside the other. Transparent colors on the visible Image Layer will only reveal the background color (if applied).

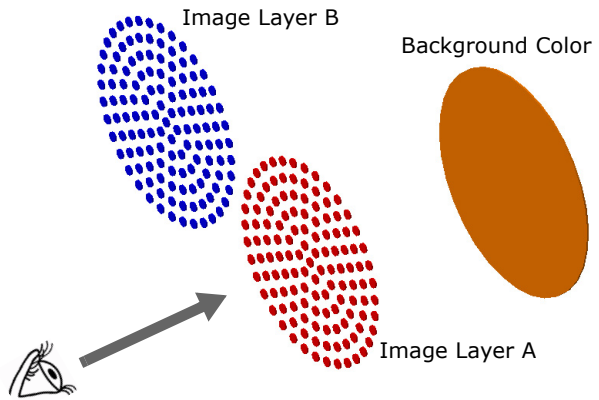

Chapter 9

Image Graphics Control

You can apply a variety of color mixing options, transitions and effects to each individual Image layer in Standard or Enhanced protocol modes.

The parameters described in this chapter are adjustable for each Image you define in Standard or Enhanced protocol for SHOWPIX and StudioPix fixtures. Parameters for composite image intensity and effects are described in *Chapter 7: Global Control* on page 53. Color Mixing control for each image layer is found in *Chapter 6: Color Control* on page 43.

Defining Content

This chapter outlines how to select a media file from stock content or your own custom content and define its playback. Use Echo software to upload custom content to your SHOWPIX or StudioPix fixture. Echo converts, organizes, and identifies content by source (preloaded stock content or custom User content) and DMX value. For more information on using Echo software to view and manage content. For more information, refer to the Echo Software User Manual available on the SHOWPIX support page at highend.com/support.

Two parameters control content selection. To define an image you have to set DMX values greater than 0 for the **Media Folder**, and **Media File** parameters.

Note: *SHOWPIX and StudioPix fixtures contain identical Stock Content files. There will be some variation in some media files since the LED array is a different size for the two fixtures.*

Media Folder

This parameter defines a folder (directory) containing a collection of media files. The media files within the assigned folder can then be selected using the Media File parameter. DMX values for folders are assigned as follows:

- DMX values = 1-40 are used or reserved for stock content
- DMX values = 41-250 are reserved for user content
- DMX values = 251-255 are reserved.

Default DMX Value = 1 (Lenses)

The following table describes the stock content folders available on SHOWPIX and StudioPix fixtures.

Media Folder Descriptions

DMX Value	Media Folder Name	Content Description
1	Lenses	Optimized static patterns that produce unique lens looks for wash light applications
2	Backgrounds	Animated Images with no black pixels to be used behind a transparent icon, lens, or moving image
3	Chasing	Changing animations that repeat patterns
4	Marquee	Frame by frame LED animations
5	Atmospherics	Natural, organic, and fluid movements and animations
6	Elegant	Slow graceful flowing
7	Shimmer	Sparkling and elegant
8	Fiery	Flames, explosions, etc
9	Spinning	Rotating and turning animations
10	Icons	Recognizable images such as alpha numerics, symbols and emblems
11	Realistic	Representations of real life imagery
12	Flashing	Strobing and flashing images
41-250	Open	Available for user content
251	Pixellage Content	Select this option when the Image file is outputting pixellage content
255	Pixel Mapping Input	Select the pixel mapping option when using Enhanced DMX protocol mode

Media File

The Media File parameter lets you identify a media file. You can supplement the large library of stock content with custom files. This parameter selects media files from within the folder defined by the Media Folder parameter.

For a reference of files available as stock content with your SHOWPIX or StudioPix fixture, go to the *Stock Content Guide* link on the SHOWPIX or StudioPix support page on <http://www.highend.com/support/LED/>. You can also preview images of media files in the Echo application. For more information, refer to the Echo Software User Manual available on the SHOWPIX support page at highend.com/support.

Default DMX Value: 0 = No file selected

Frame

The frame parameter provides a method to dial or scrub through the frames of an image file. A file can have from 1 to 256 frames. The frame parameter automatically scales the total number of frames in a movie across the 256 DMX values of the frame parameter. For example, a media file with 12 frames will have frame 1 at DMX 0 and frame 12 at 255, with the other frames evenly distributed across the 256 DMX values.

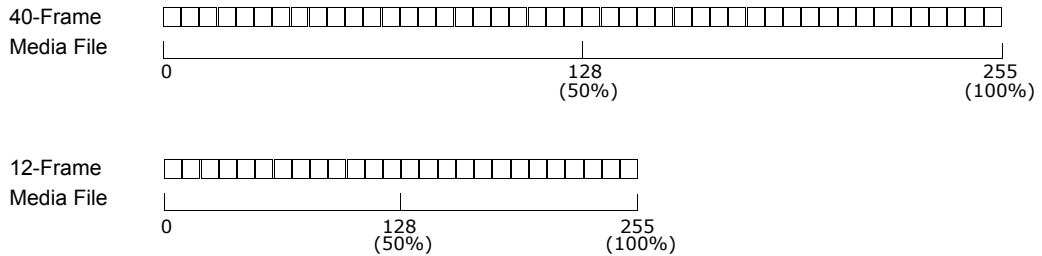

This scaling allows for full live control of all frames of a media file from a single fader, thus ensuring that the first and last frames are always at the limits of the fader. This feature is an essential element that provides for the DMX Scratch functionality.

Frame Default DMX Value: 0 = The first frame of a media file is the playback start point.

Note: *When the playback mode parameter is set to Static Frame, use the frame parameter to select a frame to display. Several stock content files such as lenses or alphanumeric can be used in this manner to display a single image from a file.*

DMX Scratch™

The **DMX Scratch™** feature is a dynamic tool that allows for live control of content playback. DMX Scratch allows the lighting operator to “scratch” a fader and manually adjust the content to synchronize with music or spoken words. To configure a fader for DMX scratch:

1. Create a “setup” cue that selects content, enables the static frame play mode, and selects frame 1 of the file.
2. File #11 in Folder #11 is titled “Lips-Scratch” and allows for a “talking lips” effect for DMX Scratch.
3. In a different cuelist, create a “scratching” fader by recording a cue that contains a value of 255 for the media frame.
4. Assign the fader for this cuelist to crossfade the values stored within the cue (“crossfade IPCB” on Wholehog consoles).

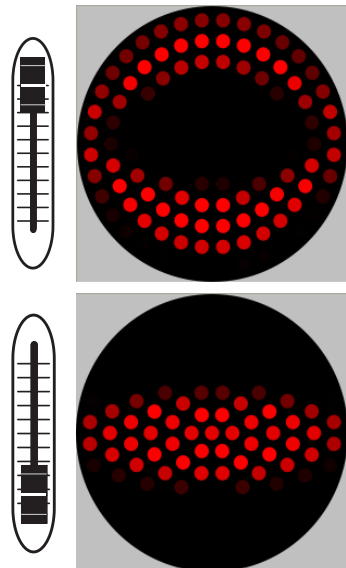

5. Playback the setup cue from step one and then manually run the fader from steps 2 and 3.

As you move the fader you should see the lips open and close. Defining Playback

After selecting a media file, you can choose from several Playback Modes and assign a Playback Speed.

Playback Mode

A **Playback Mode** parameter for each image layer allows several playback options.

Default DMX Value: 0 = Plays forward in a continuous loop

DMX Value	Playback Mode	Description
0	Loop Forward	Plays the media file forward, looping continuously.
1	Loop Reverse	Plays the media file in reverse, looping continuously.
2	Once Forward	Plays the media file forward and holds on the last frame
3	Once Reverse	Plays the media file forward and holds on the first frame
4	Random	Plays the frames of the file in a random order.
5	Bounce	Plays the media file forward then reverse, looping continuously.
6	Static Frame	Displays the frame that has been defined by the Frame parameter, (see <i>Frame</i> on page 67)
7	Loop Forward w/ intensity >0	Plays the media file forward, looping continuously. Plays only when the Dim parameter value is greater than zero.
8	Loop Reverse w/ intensity >0	Plays the media file in reverse, looping continuously. Plays only when the Dim parameter value is greater than zero.
9	Once Forward w/ intensity >0	Plays the media segment forward and holds on the last frame. Plays only when the Dim parameter value is greater than zero.
10	Once Reverse w/ intensity >0	Plays the media segment forward and holds on the last frame. Plays only when the Dim parameter value is greater than zero.
11	Random w/ intensity >0	Plays the frames of the file in a random order. Plays only when the Dim parameter value is greater than zero.
12	Bounce w/ intensity >0	Plays the media file forward then reverse, looping continuously. Plays only when the Dim parameter value is greater than zero.

Playback Speed

The **Playback Speed** parameter controls the speed of the selected media file's Playback Mode.

Default DMX Value: 128 = Playback at normal speed.

A DMX value of 0 or 128 (50%) plays back media files at the original recorded speed. DMX values from 1 to 127 plays the media file back at an increasing speed, from slowest to the original recorded speed. Values from 129-255 set playback speed from faster than normal to fastest speed.

Rotation

The **Rotation** parameter for each image layer controls the media file rotation. You can rotate a media file up to 360° around the Z axis.

Default DMX Value: 0 = no rotation

DMX values between 0 and 128 (50%) control indexed rotation from 0° - 360°. At 128 (50%), rotation stops. When the DMX value is greater than the 128 (50%), the image begins rotating continuously. DMX values from 128 (50%) to 191 (75%) decrease the speed of continuous clockwise rotation. A DMX value = 191 stops rotation and values from 191 (75%) to 255 (100%) increase continuous rotation speed in a counterclockwise direction.

Tip : If you want to index the rotation counterclockwise, set the starting DMX value = 128 (50%) and move toward zero.

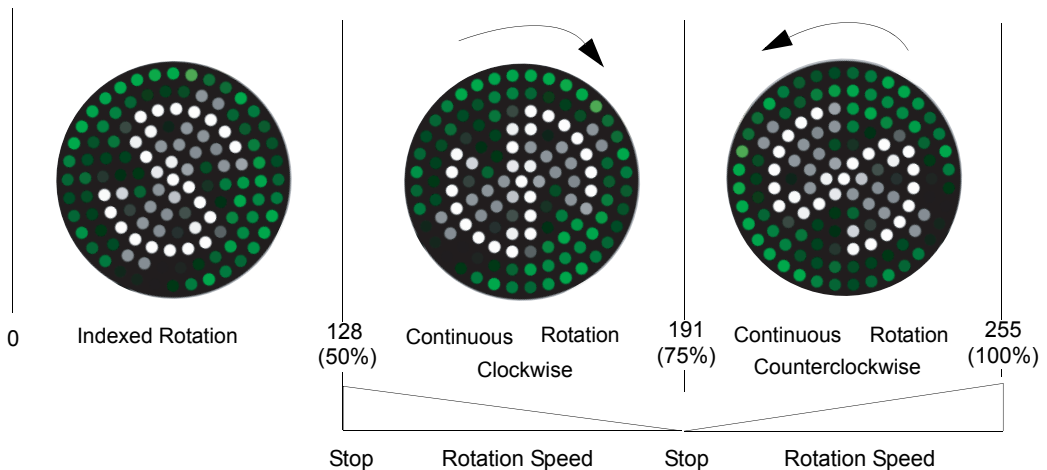
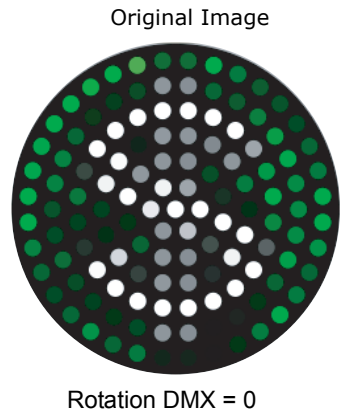

Scale Parameter

You can magnify or reduce image size using the Scale Parameter.

Default DMX Value: 128 (50%) = Normal Scale

The Scale parameter adjusts the size of the image up to approximately 10x its original size. At a DMX value of zero, the image expands to the maximum size. At the midpoint of the DMX value range, the image is normal size. When the DMX value is increased from the midpoint, the image is reduced to its minimum size at a value of 255 (100%).

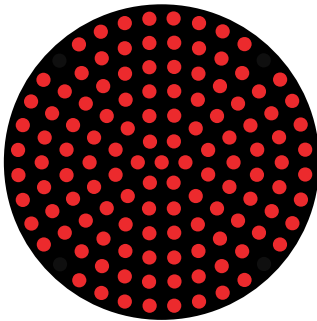

Scale DMX = 65 (25%)

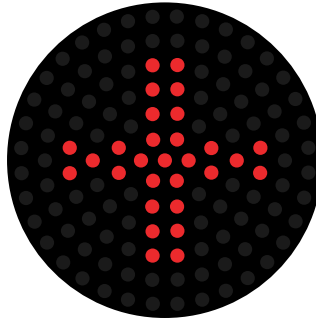

Scale DMX = 127 (50%)

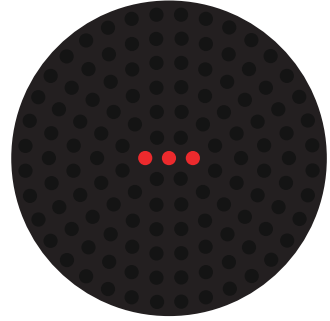

Scale DMX = 255 (100%)

Note: *At some scales, no image may be produced*

Changing Image Position

You can reposition a selected image as it appears on the array. The following parameters act on an individual image.

X Position Parameter

The **X Position** parameter moves the image along the x axis.

Default DMX Value: 128 (50%) = image centered in frame

The midpoint of the DMX value range centers the image on the X-axis. Values below the DMX midpoint move the image right, and values above the DMX midpoint move the image to the left.

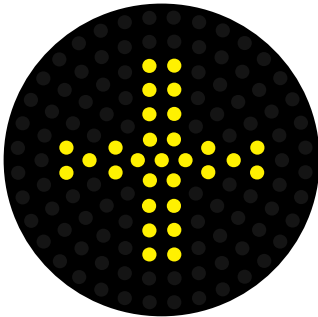

X Position DMX = 128 (50%)

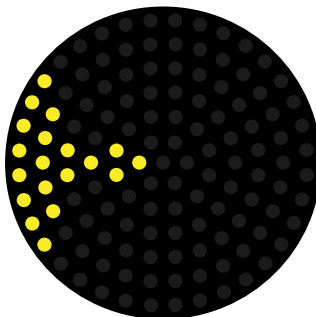

X Position DMX = 180 (70%)

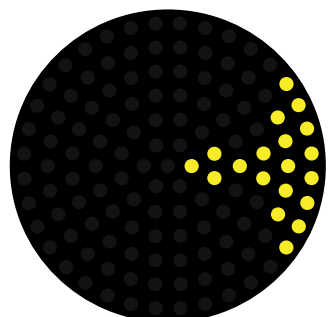

X Position DMX = 76 (30%)

Y Position Parameter

The **Y Position** parameter moves your object along the x axis.

Default DMX Value: 128 (50%) = image centered in frame.

The midpoint of the DMX value range centers the image on the Y-axis. Values below the DMX midpoint move the image up, and values above the DMX midpoint move the image down.

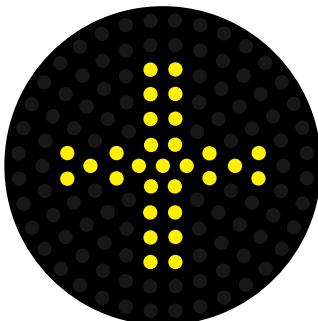

Y Position DMX = 128 (50%)

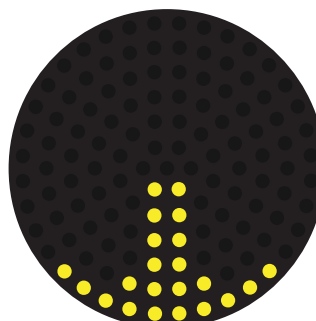

Y Position DMX = 180 (70%)

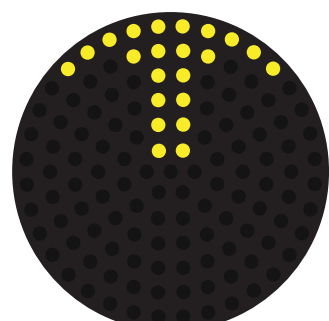

Y Position DMX = 76 (30%)

Image Transition

In Standard and Extended protocol, you can choose between several **Transition Mode** options and use the **Transition Speed** parameter to adjust the option.

Transition Mode

Transition Default DMX Value: 0 = Normal playback with no transition

Transition Mode controls the pixel transition of a movie file from frame to frame on the image layer. By default, frames will snap from one to the next, however different frame transitions can be selected to create unique playback of image files.

Transition Speed

The Transition Speed parameter will adjust the speed of the selected transition mode as the file changes from frame to frame.

Transition Speed Default DMX Value: 128 (50%) = Normal playback speed

The following table describes the **Transition Mode** options available and the type of adjustment you can make to the option using the **Transition Speed** parameter.

DMX Value	Transition Mode	Description	Transition Speed Function
0	Normal	Normal playback	No effect
1	Snap/Fade	Snaps from the current frame to the next frame and then fades out the first frame	Adjusts the duration of the fade between frames
2	Fade/Snap	Fades out the current frame and then snaps to the next frame	Adjusts the duration of the fade between frames
3	Strobe	Flashing crossfade from frame to frame	Adjusts the speed of the fade between frames
4	Trails	Retains a partial fade of the current frame added to the new frame	Adjusts the amount of decay from the previous frame

Note: *SHOWPIX and StudioPix fixtures also allow dynamic transitions between the image layers when adjusting the Global Transition parameter (see Global Transition on page 55).*

Effect Function

The Image **Effect Function** parameter provides effects that can be applied to the media file in an image layer.

DMX Value	Name	Description	Adjustments	
			Modifier 1	Modifier 2
0	None	No effects selected	NA	NA
1	Strobe	Periodic strobing of the image	Rate	Not Used
2	Pan and Tilt sync	Synchronizes image movement with Pan and Tilt movement	Rate	Size
3	Shake	Shakes the current visible image along the x and/or y axis	Horizontal	Vertical
4	Bar Scan	Blacks out a portion of the image and creates a visible "bar" that scans across the LED array	Rate	Size
5	Target Scan	Blacks out a portion of the image and creates a visible "target" that scans across the LED array	Rate	Size
6	Curtain Scan	Blacks out a portion of the image and creates a "curtain" pattern (two parallel bars) that scans across the LED array	Rate	Size
7	Mirror	Mirror the visible image on the X and/or Y axis	Horizontal	Vertical
8	Brightness and Contrast	Adjusts the brightness and/or contrast of the visible image	Brightness	Contrast
9	Filters	Enables the rainbow color effect to flow through the image in a predetermined order of the LEDs	Selects Filter	Rate
10	Flip	Flips the visible image on the X and/or Y axis	Horizontal	Vertical

Pixel Mapping

When using Enhanced mode protocol, RGB pixels can be "inserted" in place of an image file within the graphics engine. This provides the ability to fully utilize the graphic engine features when pixel mapping the LEDs.

SHOWPIX fixtures have 127 LEDs that can be mapped and StudioPix has 61. To enable the pixel mapping input, select Folder 255 File 1. The resulting image from the appropriate DMX channels for the pixel mapping will be routed into the graphics engine and behave the same as internal content.

Note: *The transparent color and several color effects require image files to function and will not function with pixel mapped input.*

Appendix A:

MSpeed Conversion Table

The following table lists the MSpeed (motor) movement times and their corresponding DMX controller values. If you have a numeric-type controller, use the Value Decimal (dec.) column. If you have a fader-type controller, use the Value Percentage (%) column. If your controller allows you to program hex values, use the Value (hex) column.

Time (sec.)	Value (dec.)	Value (%)	Value (hex)	Time (sec.)	Value (dec.)	Value (%)	Value (hex)	Time (sec.)	Value (dec.)	Value (%)	Value (hex)
0.15	255	100	FF	5.94	217	85	D9	23.30	179	70	B3
0.15	254	100	FE	6.25	216	85	D8	23.92	178	70	B2
0.17	253	99	FD	6.56	215	84	D7	24.54	177	69	B1
0.19	252	99	FC	6.89	214	84	D6	25.17	176	69	B0
0.21	251	98	FB	7.22	213	84	D5	25.80	175	69	AF
0.25	250	98	FA	7.56	212	83	D4	26.45	174	68	AE
0.29	249	98	F9	7.91	211	83	D3	27.10	173	68	AD
0.35	248	97	F8	8.27	210	82	D2	27.76	172	67	AC
0.41	247	97	F7	8.63	209	82	D1	28.43	171	67	AB
0.47	246	96	F6	9.00	208	82	D0	29.11	170	67	AA
0.55	245	96	F5	9.39	207	81	CF	29.80	169	66	A9
0.63	244	96	F4	9.77	206	81	CE	30.49	168	66	A8
0.73	243	95	F3	10.17	205	80	CD	31.19	167	65	A7
0.83	242	95	F2	10.58	204	80	CC	31.90	166	65	A6
0.94	241	95	F1	10.99	203	80	CB	32.62	165	65	A5
1.05	240	94	F0	11.41	202	79	CA	33.34	164	64	A4
1.18	239	94	EF	11.84	201	79	C9	34.08	163	64	A3
1.31	238	93	EE	12.28	200	78	C8	34.82	162	64	A2
1.45	237	93	ED	12.72	199	78	C7	35.57	161	63	A1
1.60	236	93	EC	13.17	198	78	C6	36.33	160	63	A0
1.75	235	92	EB	13.63	197	77	C5	37.09	159	62	9F
1.92	234	92	EA	14.10	196	77	C4	37.87	158	62	9E
2.09	233	91	E9	14.58	195	76	C3	38.65	157	62	9D
2.27	232	91	E8	15.07	194	76	C2	39.44	156	61	9C
2.46	231	91	E7	15.56	193	76	C1	39.44v	156	61	9C
2.66	230	90	E6	16.06	192	75	C0	40.23	155	61	9B
2.86	229	90	E5	16.57	191	75	BF	41.04	154	60	9A
3.07	228	89	E4	17.09	190	75	BE	41.85	153	60	99
3.29	227	89	E3	17.61	189	74	BD	42.68	152	60	98
3.52	226	89	E2	18.14	188	74	BC	43.50	151	59	97
3.76	225	88	E1	18.68	187	73	BB	44.34	150	59	96
4.00	224	88	E0	19.23	186	73	BA	45.19	149	58	95
4.25	223	87	DF	19.79	185	73	B9	46.04	148	58	94
4.52	222	87	DE	20.36	184	72	B8	46.90	147	58	93
4.78	221	87	DD	20.93	183	72	B7	47.77	146	57	92
5.06	220	86	DC	21.51	182	71	B6	48.65	145	57	91
5.34	219	86	DB	22.10	181	71	B5	49.54	144	56	90
5.64	218	85	DA	22.70	180	71	B4	50.43	143	56	8F

Time (sec.)	Value (dec.)	Value (%)	Value (hex)	Time (sec.)	Value (dec.)	Value (%)	Value (hex)	Time (sec.)	Value (dec.)	Value (%)	Value (hex)
51.33	142	56	8E	102.77	95	37	5F	175.24	46	18	2E
52.24	141	55	8D	104.05	94	37	5E	176.92	45	18	2D
53.16	140	55	8C	105.35	93	36	5D	178.61	44	17	2C
54.09	139	55	8H	106.65	92	36	5C	180.30	43	17	2B
55.02	138	54	8A	107.96	91	36	5B	182.01	42	16	2A
55.96v	137	54	89	109.28	90	35	5A	183.72	41	16	29
56.91	136	53	88	110.61	89	35	59	185.44	40	16	28
57.87	135	53	87	111.94	88	35	58	187.17	39	15	27
58.84	134	53	86	113.28	87	34	57	188.90	38	15	26
59.81	133	52	85	114.63	86	34	56	190.65	37	15	25
60.79	132	52	84	115.99	85	33	55	192.40	36	14	24
61.78	131	51	83	117.36	84	33	54	194.16	35	14	23
62.78	130	51	82	118.73	83	33	53	195.92	34	13	22
63.79	129	51	81	120.12	82	32	52	197.70	33	13	21
64.80	128	50	80	121.5v	81	32	51	199.48	32	13	20
65.82	127	50	7F	122.91	80	31	50	201.28	31	12	1F
66.85	126	49	7E	124.31	79	31	4F	203.08	30	12	1E
67.89	125	49	7D	125.73	78	31	4E	204.88	29	11	1D
68.94	124	49	7C	127.15	77	30	4D	206.70	28	11	1C
69.99	123	48	7B	128.58	76	30	4C	208.52	27	11	1B
71.05	122	48	7A	130.02	75	29	4B	210.36	26	10	1A
72.13	121	47	79	134.39	72	28	48	212.19	25	10	19
73.20	120	47	78	135.86	71	28	47	214.04	24	9	18
74.29	119	47	77	137.34	70	27	46	215.90	23	9	17
75.38	118	46	76	138.82	69	27	45	217.76	22	9	16
76.49	117	46	75	140.32	68	27	44	219.63	21	8	15
77.60	116	45	74	141.82	67	26	43	221.51	20	8	14
78.71	115	45	73	143.33	66	26	42	223.40	19	7	13
79.84	114	45	72	144.85	65	25	41	225.30	18	7	12
80.98	113	44	71	146.38	64	25	40	227.20	17	7	11
82.12	112	44	70	147.92	63	25	3F	229.11	16	6	10
83.27	111	44	6F	149.46	62	24	3E	231.03	15	6	0F
84.43	110	43	6E	151.01	61	24	3D	232.96	14	5	0E
85.59	109	43	6D	152.57	60	24	3C	234.90	13	5	0D
86.77	108	42	6C	154.14	59	23	3B	236.84	12	5	0C
87.95	107	42	6B	155.71	58	23	3A	238.79	11	4	0B
89.14	106	42	6A	157.30	57	22	39	240.75	10	4	0A
90.34	105	41	69	158.89	56	22	38	242.72	9	4	09
91.55	104	41	68	160.49	55	22	37	244.70	8	3	08
92.76	103	40	67	162.09	54	21	36	246.68	7	3	07
93.98	102	40	66	163.71	53	21	35	248.68	6	2	06
95.21	101	40	65	165.33	52	20	34	250.68	5	2	05
96.45	100	39	64	166.96	51	20	33	246.68	7	3	07
97.70	99	39	63	168.60	50	20	32	248.68	6	2	06
98.95	98	38	62	170.25	49	19	31	250.68	5	2	05
100.22	97	38	61	171.91	48	19	30	252.68	4	2	04
101.49	96	38	60	173.57	47	18	2F				

Appendix B:

Important Safety Information

Warning: For Continued Protection Against Fire

1. This equipment is designed for use with specified LED only. Use of any other type LED may be hazardous and may void the warranty.
2. Do not mount on a flammable surface.
3. Maintain minimum distance of 1.0 meter (.9 feet) from combustible materials.
4. Replace fuses only with the specified type and rating.
5. Observe minimum distance to lighted objects of 1 meter (3.9 feet).
6. This equipment for connection to branch circuit having a maximum overload protection of 20 A.

Warning: For Continued Protection Against Electric Shock

1. If this equipment was received without a line cord plug, attach the appropriate line cord plug according to the following code:
 - brown–live
 - blue–neutral
 - green/yellow–earth
2. In the United Kingdom, the colours of the cores in the mains lead of this equipment may not correspond with the coloured markings identifying the terminals in your plug, proceed as follows:
 - the core which is coloured green and yellow must be connected to the terminal in the plug which is marked with the letter E or by the earth symbol , or coloured green or green and yellow.
 - the core which is coloured blue must be connected to the terminal which is marked with the letter N or coloured black.
 - the core which is coloured brown must be connected to the terminal which is marked with the letter L or coloured red.
3. Class I equipment. This equipment must be earthed.
4. Equipment suitable for dry locations only. Do not expose this equipment to rain or moisture.
5. Disconnect power before re-lamping or servicing.
6. Refer servicing to qualified personnel

Warning: For Continued Protection Against Injury To Persons

1. Use secondary safety cable when mounting this fixture.
2. Equipment surfaces may reach temperatures up to 160° C (320° F). Allow a minimum of 10 minutes for cooling before handling.

Appendice B: Importantes Informations Sur La Sécurité

Mise En Garde: Pour Une Protection Permanente Contre Les Incendies

1. Cet appareil est conçu pour l'usage avec les LED spécifiées seulement. Son utilisation avec tout autre type de LED peut être dangereuse et annuler la garantie.
2. Ne pas monter les lampes sur une surface inflammable.
3. Maintenir à une distance minimum de 1.0 mètre de matières inflammables.
4. Ne remplacer les fusibles qu'avec des modèles et valeurs assignées recommandés.
5. Respecter une distance minimum de 1.0 mètre par rapport aux objets éclairés.
6. Cet appareil de connection au circuit comporte une protection contre les surcharges de 20 A.

Mise En Garde: Pour Une Protection Permanente Contre Les Chocs Électriques

1. Si cet équipement est livré sans prise de cable, veuillez connecter la prise de cable correcte selon le code suivant:
 - marron - phase
 - bleu - neutre
 - vert/jaune - terre
2. Débrancher le courant avant de changer les lampes ou d'effectuer des réparations.
3. Cet équipement doit être uniquement utilisé dans des endroits secs. Ne pas l'exposer à la pluie ou l'humidité.
4. À l'intérieur de l'équipement il n'y a pas de pièces remplaçables par l'utilisateur. Confiez l'entretien à un personnel qualifié.
5. Equipement de Classe I. Cet équipement doit être mis à la terre.

Mise En Garde: Pour Une Protection Permanente Contre Les Blessures Corporelles

1. Lors de l'assemblage, utiliser un câble de sécurité secondaire.
2. Les surfaces de l'appareil peuvent atteindre des températures de 160 C. Laisser refroidir pendant 5 minutes avant la manipulation.

Anhang B: Wichtige Hinweise Für Ihre Sicherheit

Warnung: Zum Schutz Vor Brandgefahr

1. Diese Ausrüstungen sind für Gebrauch mit angegebenen LED nur entworfen. Der Gebrauch irgend eines anderen Lampentyps könnte Sie gefährden und Ihre Garantie außer Kraft setzen.
2. Das Gerät nie auf einer feuergefährlichen Fläche montieren.
3. Stets einen Mindestabstand von 1 Meter zu brennbaren Materialien einhalten.
4. Zum Ersatz nur Sicherungen verwenden, die dem vorgeschriebenen Typ und Nennwert entsprechen.
5. Einen Mindestabstand von 1 Meter zu den angestrahlten Objekten einhalten.
6. Dieses Gerät darf nur an eine Zweigleitung mit einem Überlastungsschutz von höchstens 20 A angeschlossen werden.

Warnung: Zum Schutz Gegen Gefährliche Körperströme

1. Wenn dieses Gerät ohne einen Netzkabelstecker erhalten wurde, ist der entsprechende Netzkabelstecker entsprechend dem folgenden Code anzubringen:
 - Braun - Unter Spannung stehend
 - Blau - Neutral
 - Grün/Gelb - Erde
2. Vor dem Austauschen von Lampen oder vor Wartungsarbeiten stets den Netzstecker ziehen.
3. Diese Geräte sind nur zum Einbau in trockenen Lagen bestimmt und müssen vor Regen und Feuchtigkeit geschützt werden.
4. Servicearbeiten sollten nur von Fachpersonal ausgeführt werden. Das Gerät enthält keine wartungsbedürftigen Teile.
5. Dieses Gerät gehört zur Klasse I. Dieses Gerät muß geerdet werden.

Warnung: Zum Schutz Vor Verletzungen

1. Verwenden Sie bei der Installation des Beleuchtungskörpers ein zusätzliches Sicherheitskabel.
2. Die Oberflächen des Gerätes können Temperaturen bis zu 160 C erreichen. Vor dem Anfassen stets 5 Minuten lang abkühlen lassen.

Apéndice B: Información Importante De Seguridad

Advertencia: Para Protección Continua Contra Incendios

1. Este equipo se diseña para el uso con LED especificadas sólo. El uso de cualquier otro tipo de LED podrá resultar peligroso, y podrá anular la garantía.
2. No monte el equipo sobre una superficie inflamable.
3. Mantenga una distancia mínima de materiales combustibles de 1,0 metro.
4. Cambie los fusibles únicamente por otros que sean del tipo y la clasificación especificadas.
5. Guarda una distancia mínima a objetos iluminados de 1.0 metro.
6. Este equipo debe conectarse a un circuito que tenga una protección máxima contra las sobrecargas de 20 A.

Advertencia: Para La Protección Continua Contra Electrocuiones

1. Si se recibió este equipo sin el enchufe de alimentación, monte usted el enchufe correcto según el clave siguiente:
 - moreno - vivo
 - azul - neutral
 - verde/amarillo - tierra
2. Desconecte el suministro de energía antes de recambiar lámparas o prestar servicio de reparación.
3. Questa apparecchiatura e' da usarsi in ambienti secchi. Non e' da essere esposta ne alla pioggia ne all' umidita'.
4. Derive el servicio de reparación de este equipo al personal calificado. El interior no contiene repuestos que puedan ser reparados por el usuario.
5. Equipo de Clase I. Este equipo debe conectarse a la tierra.

Advertencia: Para Protección Continua Contra Lesiones Corporales

1. Al montare questa apparecchiatura, usare un secondo cavo di sicurezza.
2. Las superficies del equipo pueden alcanzar temperaturas máximas de 160 grados centígrados. Deje que se enfríen por 5 minutos antes de tocarlas.

Appendice B: Importanti Informazioni Di Sicurezza

Avvertenza: Per Prevenire Incendi

1. Quest'apparecchiatura è disegnata per l'uso con le LED specificate soltanto. L'uso di qualunque altra LED di tipo può essere pericoloso e può nullo la garanzia.
2. Da non montare sopra una superficie infiammabile.
3. Mantenere l'apparecchio a un minimo di 1.0 metri di distanza dai materiali combustibili.
4. Rimpiazzare i fusibili usando soltanto quelli del tipo e della taratura adatta.
5. Mantenere una distanza minima di 1.0 metri dagli oggetti accesi.
6. Questa apparecchiatura e' da collegarsi ad un circuito con una protezione da sovraccarico massima di 20 amperes.

Avvertenza: Per Prevenire Le Scosse Elettriche

1. Se questa apparecchiatura è stata consegnata senza una spina del cavo di alimentazione, collegare la spina appropriata del cavo di alimentazione in base ai seguenti codici:
 - marrone - sotto tensione
 - blu - neutro
 - verde/giallo - terra
2. Disinnestare la corrente prima di cambiare la lampadina o prima di eseguire qualsiasi riparazione.
3. Este equipo se adecua a lugares secos solamente. no lo exponga a la lluvia o humedad.
4. Per qualsiasi riparazione rivolgersi al personale specializzato. L'utente non deve riparare nessuna parte dentro l'unita'.
5. Aparecchio di Classe I. Questa apparecchiatura deve essere messa a terra.



Avvertenza: Per Non Ferire Ad Altre Persone

1. Use cable secundario de seguridad al montar este aparato.
2. Le superfici della apparecchiatura possono arrivare a temperature di 160 gradi centigradi (194 gradi f). Aspettare 5 minuti prima di maneggiare.

Vigtig Sikkerhedsinformation

Advarsel: Beskyttelse mod elektrisk chock.

VIGTIGT!

LEDEREN MED GUL/GROEN ISOLATION MAA KUN TILSLUTTES KLEMME MAERKET 
ELLER .